

Hoshimoto

切削品カタログ

CUTTING PRODUCTS CATALOG

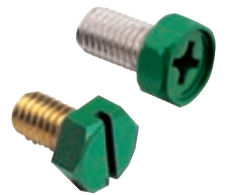

株式会社 **ホシモト**

<p>ボス・ビス TAPPED TUBES・KNOBS</p>	B (SS)・SB (SUS)・BA (AL) P.1	BN (SS)・SBN (SUS)・BNA (AL) P.2	BN (SS) P.3	H-10 (SS)・SH-10 (SUS) P.4	H-12 (SS)・SH-12 (SUS) P.6	H-11 (SS)・SH-11 (SUS) P.6	
	B-80 (SS)・SB-80 (SUS) P.7	B-90 (SS)・SB-90 (SUS) P.8	B-91 (SS)・SB-91 (SUS) P.9	EG (SS) P.9	EK (SS)・EKZ (SS) P.10	EO (SS)・EOZ (SS) P.11	
	EOZ (+) P.12	K-1 (BS) P.13	K-3 (BS)・SK-3 (SUS) P.13	K-2 (BS)・SK-2 (SUS) P.14	K-4 (BS)・SK-4 (SUS) P.14	K-5 (SS) P.15	
	K-7 (BS) P.15	KP-9 (BS) P.16	KP-6 (SS) P.16	SK-17 (SUS) P.17	K-8 (BS) P.17		
<p>取手 PULLS</p>	K-30 (SS)・SK-30 (SUS) P.18	K-31 (SS)・SK-31 (SUS) P.18	K-32 (BS) P.19	K-33 (SS) P.19	K-30-W (BS)・SK-30-W (SUS) P.19	K-34 (SS)・SK-34 (SUS) P.20	
	K-35 (SS)・SK-35 (SUS) P.20	K-36 (SS) P.21	K-37-2 (ZDC) P.21	KP-37-2~3 P.21	K-38 P.22	K-39 (ZDC)・KP-39 P.22	
	SK-43R (SUS) P.23	K-85-3 (ZDC) P.23	K-80 P.24	K-82 P.25			
<p>ステー STAYS</p>	C-211 (SS) P.26						
<p>アイボルト EYE BOLTS</p>	CB (SS)・SCB (SUS) P.27	CN (SS)・SCN (SUS) P.28	BW (SS) P.28	BG (BS)・BGK (BS)・BGS (SS) P.29			
<p>六角ボス HEXAGONAL TAPPED BOSSES</p>	ASF-300E~800E (SS) P.31	ASU-300~800 (SUS) P.33	ASB-300E~600E (BS) P.36	AS-300~500 (POM) P.39			
<p>丸ボス ROUND TAPPED BOSSES</p>	ARB-300E~400E (BS) P.41	ARB-300SE~400SE (BS) P.42	ARU-300 (SUS) P.43	ARU-300S (SUS) P.44	AR-300~500 (POM) P.45		
<p>六角サポーター HEXAGONAL SPACER</p>	BSF-300E~800E (SS) P.47	BSU-300~800 (SUS) P.49	BSB-300E~500E (BS) P.52	BS-300E~400E (POM) P.54	ESB-300E~400E (BS) P.56	ESU-300 (SUS) P.56	
<p>丸サポーター ROUND SPACER</p>	BRB-300E~400E (BS) P.57	BRB-300SE~400SE (BS) P.58	BRU-300 (SUS) P.59	BRU-300S (SUS) P.59	BR-300A~400A (POM) P.60		
<p>ローレットビス KNURLED KNOBS</p>	NB-300A~500A (BS) P.61	NB-300B~500B (BS) P.63	NB-300E~500E (BS) P.64	NB-300C~500C (BS) P.65	NB-300D~500D (BS) P.66	NB-300F~500F (BS) P.67	

ピクトの説明 Mark description



新製品
New products

新発売・新掲載商品を示します。

It shows the new products.



標準在庫品
Standard stock

原則として常時在庫しております。ご注文日、もしくは翌日(休日は除く)には、出荷・配送させていただきます。但し、大量のご注文になる場合にはご連絡ください。

It's always in stock and prepared for immediate release. We will release/deliver the standard stock in order date or the next day(except holidays). However, please contact us regarding the large orders.



準在庫品
Sub-inventory

数量を限定して在庫しておりますので、ご注文の際には在庫の確認をお願いします。品切れの場合は通常3~7日での発送となります。

We have limited quantities in stock. So thank you to confirm the stock when ordering. If it is out of stock, it usually takes about three to seven days.



RoHS指令対応品
Products Conforming to RoHS Directive

特定有害物資の使用制限に関するEUの指令、RoHS指令に対応しております。

Conform to the restriction of certain hazardous materials in the EU RoHS Directive.



RoHS指令対応可能
Available products in RoHS directive

RoHS指令に対応可能です。お問い合わせください。

Products are available in RoHS directive. Please contact us.



防水
Waterproof

Oリング・パッキン等をSETした防水タイプの製品です。

Waterproofing products with O-ring and gasket.



CAD 2D
CAD 2D

2次元(dx)データがあります。

2D(dx) data is available.



取扱い商品
Product Handling

一般市販品を示し、寸法及びデータは参考数値ですので、現物にてご確認ください。また予告なく仕様の変更及び製造を中止する場合がありますので、予めご了承ください。

Dimension and data of general products on the market are for reference only. Please check the actual product. Please note. It may be changed without notice regarding specifications or suspension products.

カタログについて About catalog

表示方法

- 図面は全て第三角法に基づいて記載しております。
- 材質、表面仕上の表示は主な部品のみとし、JIS規格で定められた呼称・記号を採用しております。
- パネル穴明け寸法は、取付け施行時の参考にご利用ください。

ご注意

- 当カタログのデータは、規格値ではありません。また製造の中止、並びに記載内容(形状・名称・仕様・材質・価格)については、予告なく変更することがありますので、予めご了承ください。
- ご使用に際しては、必ず貴社にて事前にテストを行い、使用目的に適合するかをご確認ください。

お願い

- 当社製品は一般工業向けに製作されたものです。特殊な用途へのご使用に際しては貴社にて事前にテストを行い、安全性をご確認の上、ご使用ください。
- ご注文の際は、必ず納期の確認をされますようお願いいたします。

価格について

- 本カタログは事業者間取引を目的に制作されており、総額表示義務の対象外のため税抜価格を表示しております。
- 本カタログには商品価格が記載されておりますが、予告なく価格を変更する場合がありますので、ご注文の際は価格の確認をされますようお願いいたします。
- 大量のご注文はお見積りいたします。お問い合わせください。

DISPLAY METHOD

- The drawings are described on the basis of all the great trigonometry.
- The main components of material and surface finish are only indicated, and symbol/name, designation are determined by JIS are used.
- Please refer to panel drilling dimension when installing.

NOTES.

- The data in this catalog are not standard values. Please note. It may be changed without notice regarding suspension products, content description(shape・name・specification・material・price).
- Please check the suitability of the intended use before your pre-test for certain.

REQUEST

- Our product was originally produced for general industry. Please use after safety check through pre-test regarding special uses.
- Please be sure to confirm your delivery when ordering.

PRICE

- This brochure has been produced for business transactions. Products are exempt from "consumption tax obligation", so price without tax is listed.
- Current commodity prices is listed in catalog. Please note. It may be changed without notice regarding price.
- Please feel free to contact us and ask for a quote about larger orders.

スタットビス

STUD BOLTS

B(SS)・SB(SUS)・BA(AL)



B-645



SB-645

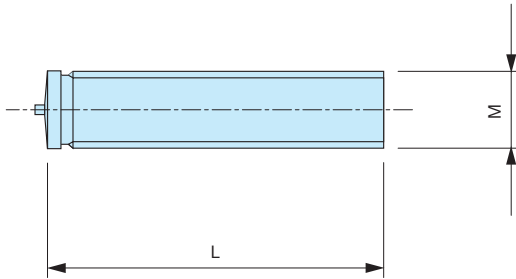

- | | |
|----------------|--|
| 特 徴
Feature | <ul style="list-style-type: none"> ● ストレート型 (フランジ型もあります) ● Straight type (Flange type is also available.) |
| 材 質 | <ul style="list-style-type: none"> ● B-/鉄 (SS) ● SB-/ステンレス (SUS304) ● BA-/アルミ (A1050) |
| 表面処理 | ● B-/銅めっき |
| 備 考 | ● 各種サイズ別注品承ります (最小LOT5000pcs以上) |
| Material | <ul style="list-style-type: none"> ● B-/Rolled steel (SS) ● SB-/Stainless steel (SUS304) ● BA-/Aluminum (A1050) |
| Finish | ● B-/Copper plating |
| Remarks | ● Various sizes are available for special ordered products. (Minimum Lot: more than 5,000pcs) |

品 番 Product No.			M	L	自 重 (g) Weight			単 価 Price		
SS	SUS	AL			SS	SUS	AL	SS	SUS	AL
B-305			3	5	0.2			¥12		
B-306	SB-306	BA-306	3	6	0.2	0.2	0.2	¥12	¥27	¥14
B-308	SB-308	BA-308	3	8	0.4	0.4	0.2	¥12	¥27	¥14
B-310	SB-310	BA-310	3	10	0.4	0.6	0.2	¥12	¥27	¥14
B-312	SB-312	BA-312	3	12	0.4	0.6	0.2	¥13	¥27	¥15
B-315	SB-315	BA-315	3	15	0.6	0.6	0.2	¥13	¥30	¥15
B-318			3	18	0.7			¥13		
B-320	SB-320	BA-320	3	20	0.8	1	0.2	¥13	¥30	¥16
B-325	SB-325		3	25	1	1		¥13	¥35	
B-330	SB-330		3	30	1.2	1.2		¥14	¥40	
B-335	SB-335		3	35	1.4	1.4		¥14	¥50	
B-340	SB-340		3	40	1.6	1.6		¥14	¥55	
B-345	SB-345		3	45	1.9	1.9		¥14	¥60	
B-350	SB-350		3	50	2.2	2.1		¥14	¥65	
B-406	SB-406		4	6	0.6	0.4		¥14	¥33	
B-408	SB-408	BA-408	4	8	0.6	0.6	0.2	¥14	¥33	¥16
B-410	SB-410	BA-410	4	10	0.8	0.8	0.2	¥14	¥33	¥16
B-412	SB-412	BA-412	4	12	1	1	0.4	¥14	¥35	¥18
B-415	SB-415	BA-415	4	15	1.2	1.2	0.4	¥14	¥35	¥18
B-418			4	18	1.4			¥14		
B-420	SB-420	BA-420	4	20	1.6	1.6	0.6	¥14	¥38	¥18
B-425	SB-425	BA-425	4	25	1.8	1.8	0.8	¥14	¥40	¥18
B-430	SB-430		4	30	2.2	2.4		¥14	¥50	
B-435	SB-435		4	35	2.6	2.6		¥16	¥55	
B-440	SB-440		4	40	3	3		¥16	¥60	
B-445	SB-445		4	45	3.4	3.2		¥16	¥65	
B-450	SB-450		4	50	3.8	3.6		¥16	¥75	
B-508	SB-508		5	8	0.9	0.9		¥16	¥34	
B-510	SB-510	BA-510	5	10	1.4	1.2	0.4	¥16	¥34	¥18
B-512	SB-512		5	12	1.6	1.4		¥16	¥36	
B-515	SB-515	BA-515	5	15	2	1.8	0.6	¥16	¥45	¥19
B-518			5	18	2			¥16		
B-520	SB-520	BA-520	5	20	2.4	2.4	0.8	¥16	¥50	¥19
B-525	SB-525		5	25	3	3		¥16	¥60	

品 番 Product No.			M	L	自 重 (g) Weight			単 価 Price		
SS	SUS	AL			SS	SUS	AL	SS	SUS	AL
B-530	SB-530		5	30	3.6	3.6		¥16	¥65	
B-535	SB-535		5	35	4.2	4.2		¥16	¥70	
B-540	SB-540		5	40	4.8	4.6		¥20	¥75	
B-545	SB-545		5	45	5.4	5.4		¥20	¥85	
B-550	SB-550		5	50	6	6		¥20	¥90	
B-608	SB-608		6	8	1.4	1.4		¥21	¥42	
B-610	SB-610	BA-610	6	10	1.8	1.8	0.6	¥21	¥42	¥23
B-612	SB-612		6	12	2.2	2		¥21	¥43	
B-615	SB-615	BA-615	6	15	2.8	2.6	0.8	¥21	¥45	¥25
B-620	SB-620	BA-620	6	20	3.4	3.4	1.2	¥21	¥50	¥26
B-625	SB-625		6	25	4.4	4.4		¥21	¥65	
B-630	SB-630	BA-630	6	30	5.2	5	1.8	¥22	¥70	¥28
B-635	SB-635		6	35	6.2	6		¥22	¥75	
B-640	SB-640		6	40	7	6.8		¥23	¥80	
B-645	SB-645		6	45	7.6	7.8		¥29	¥85	
B-650	SB-650		6	50	8.6	8.6		¥29	¥95	
B-810	SB-810		8	10	3.2	3		¥29	¥55	
B-812	SB-812		8	12	3.8	3.8		¥29	¥60	
B-815	SB-815		8	15	4.8	4.6		¥30	¥60	
B-820	SB-820		8	20	6.4	6.2		¥30	¥65	
B-825	SB-825		8	25	7.8	7.6		¥33	¥70	
B-830	SB-830		8	30	9.4	9.2		¥33	¥75	
B-835	SB-835		8	35	10.8	11		¥34	¥80	
B-840	SB-840		8	40	12.6	12.4		¥35	¥90	
B-845	SB-845		8	45	13.8	14		¥36	¥100	
B-850	SB-850		8	50	15.2	15.4		¥38	¥110	
B-855			8	55	16.8			¥40		
B-1015			10	15	7.5			¥39		
B-1020	SB-1020		10	20	10	10.2		¥39	¥150	
B-1025	SB-1025		10	25	12.4	12.4		¥42	¥165	
B-1030	SB-1030		10	30	14.8	15.3		¥46	¥175	
B-1035			10	35	17			¥48		
B-1040	SB-1040		10	40	19.6	20.3		¥55	¥200	

スタットボス

STUD TAPPED TUBES

BN(ss)・SBN(SUS)・BNA(AL)

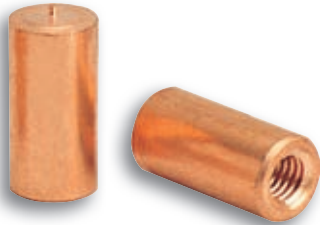

BN-3-10

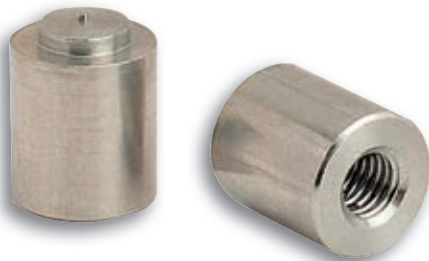

SBN-5-6

BN-1~3

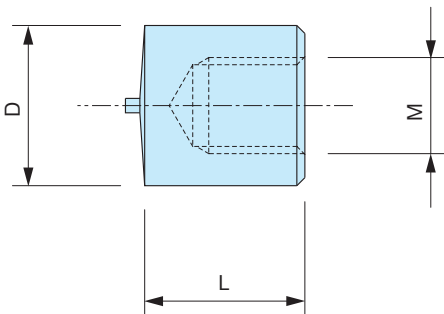

BN-4~5

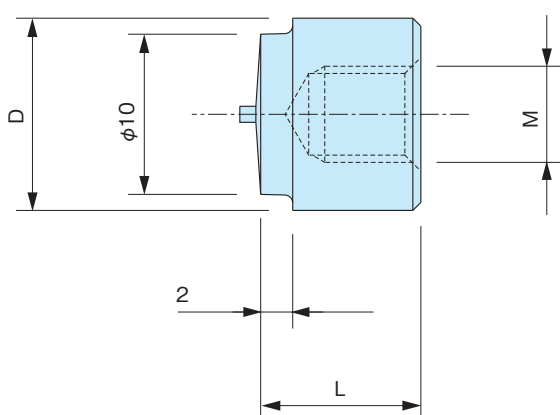

特徴 ●各種サイズとりそろえています。
Feature ●Various sizes

材質 ●BN-鉄(SS)
●SBN-ステンレス(SUS304)
●BNA-アルミ(A1050)

表面処理 ●BN-銅めっき
備考 ●各種サイズ別注品承ります

Material ●BN-/Rolled steel (SS)
●SBN-/Stainless steel (SUS304)
●BNA-/Aluminum (A1050)

Finish ●BN-/Copper plating
Remarks ●Various sizes are available for special ordered products.

品番 Product No.			Size D×L×M	有効 深さ Effective depth	自重(g) Weight			単価 Price		
SS	SUS	AL			SS	SUS	AL	SS	SUS	AL
BN-1-1	SBN-1-1		6×5×M3	3	1	1		¥25	¥145	
BN-1-2	SBN-1-2		6×6×M3	4	1.2	1.2		¥25	¥145	
BN-1-2L			6×6.6×M3	4	1.3			¥30		
BN-1-3	SBN-1-3		6×7×M3	4	1.2	1.2		¥25	¥145	
BN-1-4	SBN-1-4	BNA-1-4	6×8×M3	5	1.4	1.4	0.6	¥30	¥155	¥90
BN-1-5	SBN-1-5		6×9×M3	6	1.6	1.6		¥30	¥155	
BN-1-6	SBN-1-6		6×10×M3	7	1.8	1.8		¥30	¥155	
BN-1-7	SBN-1-7	BNA-1-7	6×12×M3	8	2.2	2.2	0.8	¥30	¥155	¥95
BN-1-8	SBN-1-8		6×15×M3	8	2.6	2.8		¥35	¥170	
BN-1-9	SBN-1-9		6×20×M3	8	3.6	3.8		¥35	¥170	
BN-2-1	SBN-2-1		8×8×M4	5	2.6	2.6		¥35	¥170	
BN-2-2	SBN-2-2	BNA-2-2	8×10×M3	6	3.6	3.6	1.4	¥35	¥170	¥95
BN-2-3	SBN-2-3	BNA-2-3	8×10×M4	6	3.2	3.4	1.2	¥35	¥170	¥95
BN-2-3L	SBN-2-3L		8×12×M4	8	3.8	4.2		¥35	¥180	
BN-2-4	SBN-2-4	BNA-2-4	8×10×M5	6	3	2.8	1	¥35	¥170	¥95
BN-2-5	SBN-2-5	BNA-2-5	8×15×M3	9	5.4	5.2	2	¥35	¥195	¥105
BN-2-6	SBN-2-6	BNA-2-6	8×15×M4	9	4.8	4.8	1.8	¥35	¥195	¥105
BN-2-7	SBN-2-7	BNA-2-7	8×15×M5	9	4.2	4.2	1.6	¥35	¥195	¥105
BN-2-8	SBN-2-8		8×20×M4	11	6.4	6.6		¥40	¥220	
BN-2-9	SBN-2-9		8×20×M5	11	6	5.8		¥40	¥220	
BN-2-10	SBN-2-10		8×25×M4	12	7.6	8.4		¥45	¥235	
BN-3-1	SBN-3-1	BNA-3-1	10×10×M4	6	5.6	5.6	2	¥45	¥220	¥100
BN-3-2	SBN-3-2	BNA-3-2	10×10×M5	6	5.2	5	1.8	¥45	¥220	¥100
BN-3-3	SBN-3-3	BNA-3-3	10×10×M6	6	4.8	4.6	1.6	¥45	¥220	¥100
BN-3-4	SBN-3-4		10×12×M5	8	6.2	6		¥45	¥220	
BN-3-5	SBN-3-5		10×12×M6	8	5.6	5.6		¥45	¥220	
BN-3-6	SBN-3-6	BNA-3-6	10×15×M4	10	8.2	8.2	2.8	¥50	¥235	¥110
BN-3-7	SBN-3-7	BNA-3-7	10×15×M5	10	7.6	7.6	2.6	¥50	¥235	¥110
BN-3-8	SBN-3-8	BNA-3-8	10×15×M6	10	6.8	6.8	2.4	¥50	¥235	¥110
BN-3-9	SBN-3-9	BNA-3-9	10×20×M5	11	10	10.2	3.4	¥50	¥260	¥115
BN-3-10	SBN-3-10	BNA-3-10	10×20×M6	11	9	9.6	3.2	¥50	¥260	¥115
BN-3-11	SBN-3-11		10×25×M5	12	13.5	13.1		¥70	¥290	
BN-3-12	SBN-3-12		10×25×M6	16	11.8	12.5		¥70	¥290	
BN-4-1	SBN-4-1	BNA-4-1	12×10×M4	6	7.8	7.6	2.6	¥55	¥235	¥130
BN-4-2	SBN-4-2	BNA-4-2	12×10×M5	6	7.4	7.2	2.6	¥55	¥235	¥130
BN-4-3	SBN-4-3	BNA-4-3	12×10×M6	6	6.8	6.8	2.4	¥55	¥235	¥130
BN-5-1	SBN-5-1		16×10×M6	5	13.4	12.4		¥60	¥280	
BN-5-2	SBN-5-2		16×10×M8	5	11	11.2		¥60	¥280	
BN-5-3	SBN-5-3		16×15×M6	8	19.8	19.4		¥60	¥300	
BN-5-4	SBN-5-4		16×15×M8	8	18.2	17.4		¥60	¥300	
BN-5-5	SBN-5-5		16×20×M6	11	26.6	26.8		¥60	¥340	
BN-5-6	SBN-5-6		16×20×M8	11	24.4	24.2		¥60	¥340	

スタットボス(準標準)

STUD TAPPED TUBES

BN(ss)



特徴 ●各種サイズ別注品承ります。
Feature ●Various sizes are available for special ordered products.

材質 ●BN/鉄(SS)
表面処理 ●銅めっき
用途 ●配電盤・制御盤・計器盤用BOX

Material ●Rolled steel (SS)
Finish ●Copper plating
Specific Use ●Distribution boards, meter boards, etc.



BN-12-2

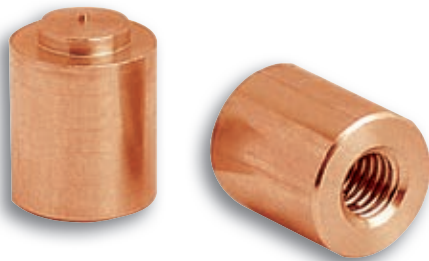

BN-15-1

BN-11~13

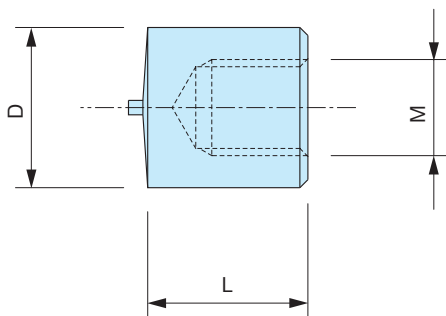

BN-15

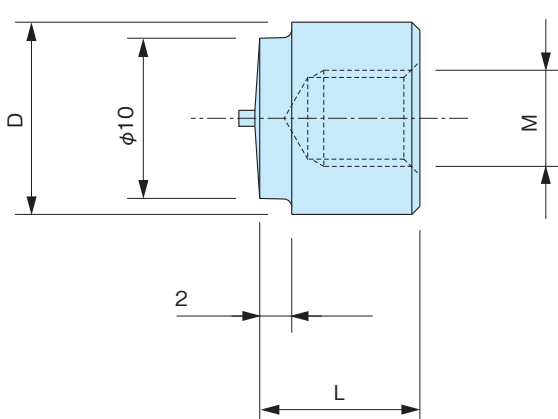

品番 Product No.	Size D×L×M	有効(深さ) Effective depth	自重(g) Weight	単価 Price
BN-11-1	6×5.5×3	3	1.1	¥30
BN-11-2	6×6.5×3	4	1.3	¥30
BN-11-3	6×7.5×3	5	1.5	¥30
BN-11-4	6×8.5×3	6	1.7	¥30
BN-11-5	6×9.5×3	7	1.9	¥35
BN-11-6	6×10×4	7	1.7	¥35
BN-11-7	6×10.5×3	7	2.1	¥35
BN-11-8	6×11×3	8	2.2	¥40
BN-11-9	6×11.5×3	8	2.3	¥40
BN-11-10	6×12×4	9	2.0	¥40
BN-11-11	6×12.5×3	9	2.5	¥50
BN-11-12	6×13×3	9	2.6	¥50
BN-11-13	6×13.5×3	10	2.6	¥50
BN-11-14	6×14×3	10	2.8	¥50
BN-11-15	6×16×3	10	3.2	¥55
BN-11-16	6×17×3	10	3.4	¥55
BN-11-17	6×18×3	10	3.6	¥55
BN-11-18	6×19×3	10	3.9	¥55
BN-11-19	6×21×3	10	4.3	¥55
BN-11-20	6×22×3	10	4.5	¥55
BN-11-21	6×23×3	10	4.7	¥60
BN-11-22	6×24×3	10	5.0	¥60
BN-11-23	6×25×3	10	5.2	¥60
BN-11-24	6×30×3	12	6.3	¥60
BN-11-25	6×35×3	12	7.4	¥60
BN-12-1	8×6×4	3	2.1	¥40
BN-12-2	8×18×4	12	6.4	¥65
BN-12-3	8×30×4	13	11.1	¥70
BN-13-1	10×30×5	12	17.1	¥75
BN-13-2	10×30×6	15	16.1	¥75
BN-15-1	16×25×8	16	33.4	¥75

丸ボス

ROUND TAPPED TUBES

H-10(SS)・SH-10(SUS)



SH-10-2



SH-10-10

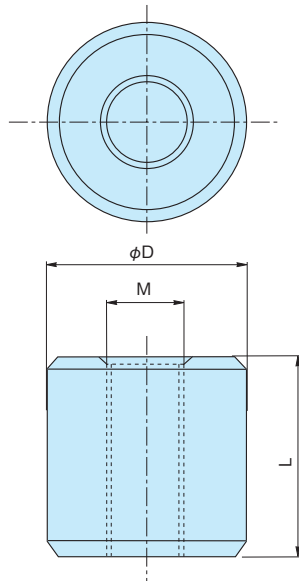

品番 Product No.		φD	L	M	製品自重 (g) Weight		単価 Price	
SS	SUS				SS	SUS	SS	SUS
H-10-1	SH-10-1	20	30	10	57.1	57.8	¥70	¥550
H-10-2	SH-10-2	20	30	8	63.1	63.5	¥60	¥550
H-10-3	SH-10-3	20	25	8	52.4	53.1	¥50	¥400
H-10-4	SH-10-4	20	20	8	41.7	42.3	¥40	¥300
H-10-5	SH-10-5	20	15	8	31.2	31.7	¥35	¥270
H-10-6	SH-10-6	15	20	8	20.6	20.9	¥30	¥180
H-10-7	SH-10-7	15	15	8	15.4	15.7	¥27	¥170
H-10-8	SH-10-8	20	10	6	22.3	22.7	¥35	¥250
H-10-9	SH-10-9	15	20	6	23.7	23.8	¥30	¥180
H-10-10	SH-10-10	15	15	6	17.5	18	¥27	¥170
H-10-11	SH-10-11	15	10	6	11.7	11.9	¥25	¥170
H-10-12	SH-10-12	15	15	5	18.4	18.6	¥27	¥170
H-10-13	SH-10-13	15	10	5	12.3	12.5	¥25	¥170
H-10-14	SH-10-14	10	10	5	4.7	4.8	¥25	¥150
H-10-15	SH-10-15	10	15	4	7.9	8	¥25	¥160
H-10-16	SH-10-16	10	10	4	4.7	5.2	¥25	¥150
H-10-17	SH-10-17	12	10	5	7.4	7.4	¥25	¥150
H-10-18	SH-10-18	15	10	4	12.7	13	¥25	¥150
H-10-19		20	20	12	33		¥70	
H-10-20	SH-10-20	20	25	10	47.5	48	¥90	¥450
H-10-21	SH-10-21	20	20	10	38.2	38.4	¥70	¥400
H-10-22		25	25	8	86.8		¥90	
H-10-23	SH-10-23	15	30	8	31	31	¥80	¥300
H-10-24		20	20	6	44.8		¥70	
H-10-25	SH-10-25	15	30	6	35.5	35.6	¥80	¥300
H-10-26	SH-10-26	12	10	6	6.6	6.6	¥30	¥150
H-10-27	SH-10-27	15	20	5	24.7	25	¥70	¥200
H-10-29		10	20	5	9.5		¥50	
H-10-30	SH-10-30	15	15	4	19.3	19.4	¥50	¥180
H-10-31		10	20	4	10.5		¥50	
H-10-32	SH-10-32	10	15	5	7	7	¥45	¥170
H-10-33		12	15	5	10.8		¥45	
H-10-34		12	15	6	10.2		¥45	

特徴 ●各種サイズ別注品承ります。
Feature ●Various sizes are available for special ordered products.

材質 ●H-10/鉄(SS400)
 ●SH-10/ステンレス(SUS304)

用途 ●配電盤・制御盤・計器盤用BOX

Material ●H-10/Rolled steel (SS400)
 ●SH-10/Stainless steel (SUS304)

Specific Use ●Distribution boards, meter boards, etc.

丸ボス(準標準)

ROUND TAPPED TUBES(SEMI-STANDARD)



H-10 (SS)・SH-10 (SUS)



SH-10-23



SH-10-106

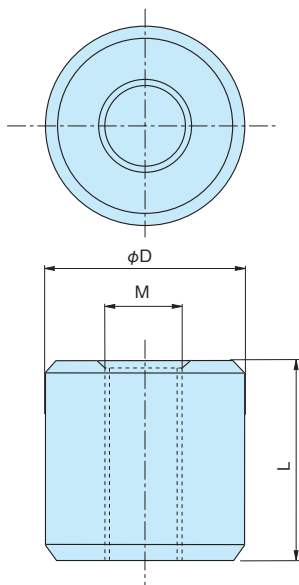

- 特徴**
●標準品に準拠する豊富なサイズを取り揃えました。
●また、その他各種サイズ別注品承ります。
- Feature**
●It is available in a variety of sizes to comply with the standard.
●In addition, also available in various other sizes as special order.

- 材質**
●H-10/鉄(SS400)
●SH-10/ステンレス(SUS304)

- 用途**
●配電盤・制御盤・計器盤用BOX

- Material**
●H-10/Rolled steel (SS400)
●SH-10/Stainless steel (SUS304)

- Specific Use**
●Distribution boards, meter boards, etc.

品番 Product No.	φD	L	M	自重(g) Weight	単価 Price
H-10-101	8	10	3	3.5	¥70
H-10-102	8	10	4	3.2	¥70
H-10-103	8	15	4	4.8	¥70
H-10-104	8	20	5	5.5	¥70
H-10-105	10	10	3	5.7	¥70
H-10-106	10	10	6	4.5	¥70
H-10-107	10	12	4	6.5	¥70
H-10-108	10	12	5	6.0	¥70
H-10-109	10	12	6	5.4	¥70
H-10-110	10	15	6	6.7	¥70
H-10-111	10	20	6	8.9	¥70
H-10-112	12	10	4	8.1	¥70
H-10-113	12	12	5	9.2	¥70
H-10-114	12	12	6	8.6	¥70
H-10-115	12	18	5	13.9	¥70
H-10-116	12	18	6	12.9	¥70
H-10-117	12	20	5	15.4	¥70
H-10-118	12	20	6	14.3	¥70
H-10-119	12	25	5	19.3	¥70
H-10-120	12	25	6	17.9	¥70
H-10-120-1	15	10	8	10	¥60
H-10-121	15	12	5	15.2	¥70
H-10-122	15	12	6	14.6	¥70
H-10-123	15	12	8	13.0	¥70
H-10-124	15	18	5	22.8	¥75
H-10-125	15	18	6	21.9	¥75
H-10-126	15	18	8	19.4	¥75
H-10-127	15	25	5	31.7	¥80
H-10-128	15	25	6	30.4	¥80

品番 Product No.	φD	L	M	自重(g) Weight	単価 Price
H-10-129	15	25	8	27.0	¥80
H-10-130	15	28	6	34.1	¥80
H-10-131	15	28	8	30.2	¥80
H-10-132	15	30	5	38.1	¥85
H-10-133	15	35	5	44.4	¥85
H-10-134	15	35	6	42.6	¥85
H-10-135	15	35	8	37.8	¥85
H-10-136	15	40	6	48.7	¥90
H-10-137	15	40	8	43.2	¥90
H-10-138	20	10	8	21.6	¥75
H-10-139	20	10	10	19.7	¥75
H-10-140	20	12	5	28.2	¥80
H-10-141	20	12	6	27.5	¥80
H-10-142	20	12	8	25.9	¥80
H-10-143	20	15	6	34.4	¥85
H-10-144	20	15	10	29.6	¥85
H-10-145	25	15	8	53.2	¥120
H-10-146	25	15	10	50.4	¥120
H-10-147	25	20	8	70.9	¥130
H-10-148	25	20	10	67.1	¥130
H-10-149	25	20	12	61.8	¥130
H-10-150	25	25	12	77.3	¥140
SH-10-106	10	10	6	4.5	¥150
SH-10-110	10	15	6	6.7	¥160
SH-10-118	12	20	6	14.4	¥160
SH-10-120	12	25	6	18.0	¥180
SH-10-120-1	15	10	8	10	¥170
SH-10-128	15	25	6	30.6	¥250

袋ボス

ROUND TAPPED TUBES

H-12(SS)・SH-12(SUS)



H-12-1

SH-12-9

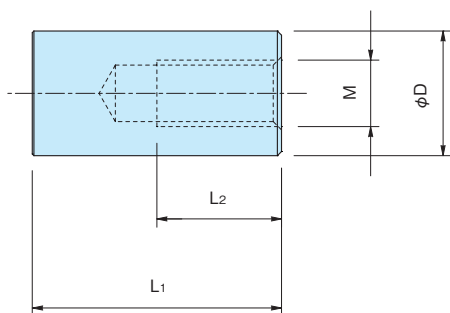

特 徴 Feature	●各種サイズ別注品承ります。 ●Various sizes are available for special ordered products.
材 質	●H-12/鉄(SS400) ●SH-12/ステンレス(SUS304)
用 途	●配電盤・制御盤・計器盤用BOX
Material	●H-12/Rolled steel (SS) ●SH-12/Stainless steel (SUS304)
Specific Use	●Distribution boards, meter boards, etc.

品 番 Product No.		φD	L ₁	L ₂	M	製品自重(g) Weight		単 価 Price	
SS	SUS					SS	SUS	SS	SUS
H-12-1	SH-12-1	12	30	10	4	25.1	25.3	¥100	¥260
H-12-2	SH-12-2	12	35	12	5	28.6	28.8	¥110	¥280
H-12-3	SH-12-3	15	40	13	6	51.5	52.1	¥125	¥370
H-12-4	SH-12-4	15	40	15	8	48.2	48.5	¥125	¥370
H-12-5	SH-12-5	15	50	13	6	65.4	66.0	¥130	¥400
H-12-6	SH-12-6	15	50	15	8	62.0	63.2	¥130	¥400
H-12-7	SH-12-7	20	40	15	8	91.3	92.1	¥160	¥600
H-12-8	SH-12-8	20	40	20	10	84.7	89.0	¥160	¥600
H-12-9	SH-12-9	20	50	15	8	115.9	116.9	¥170	¥680
H-12-10	SH-12-10	20	50	20	10	109.1	113.7	¥170	¥680

段付ボス

TAPPED TUBES WITH STEP

H-11(SS)・SH-11(SUS)



SH-11-1

SH-11-2

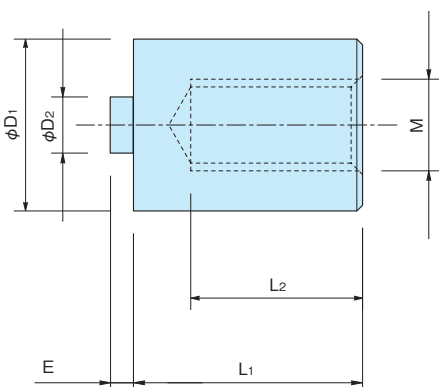

特 徴 Feature	●各種サイズ別注品承ります。 ●Various sizes are available for special ordered products.
材 質	●H-11/鉄(SS400) ●SH-11/ステンレス(SUS304)
用 途	●配電盤・制御盤・計器盤用BOX
Material	●H-11/Rolled steel (SS400) ●SH-11/Stainless steel (SUS304)
Specific Use	●Distribution boards, meter boards, etc.

品 番 Product No.		φD ₁	φD ₂	L ₁	L ₂	E	M	製品自重(g) Weight		単 価 Price	
SS	SUS							SS	SUS	SS	SUS
H-11-1	SH-11-1	15	4.9	20	15	2	8	21.8	21.7	¥48	¥300
H-11-2	SH-11-2	15	4.9	15	12	2	8	16.5	16.7	¥41	¥270
H-11-3	SH-11-3	15	4.9	15	12	2	6	18.3	18.5	¥41	¥270
H-11-4	SH-11-4	15	4.9	10	6	2	6	12.2	12.2	¥36	¥230
H-11-5	SH-11-5	12	3.9	15	12	2	5	11.6	11.6	¥38	¥230
H-11-6	SH-11-6	12	3.9	10	6	2	5	7.8	7.8	¥33	¥210
H-11-7	SH-11-7	10	3.9	15	12	1.5	5	7.6	7.3	¥36	¥230
H-11-8	SH-11-8	10	3.9	15	12	1.5	4	8.1	8.1	¥36	¥230
H-11-9	SH-11-9	10	3.9	10	6	1.5	5	5.1	5.1	¥32	¥200
H-11-10	SH-11-10	10	3.9	10	6	1.5	4	5.5	5.6	¥32	¥200
H-11-11		15	4.9	20	15	2	6	24.4		¥60	

ヒンジピン

HINGE PINS

B-80(ss)・SB-80(sus)



B-80-3

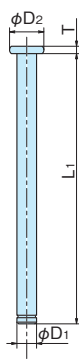

- 特 徴** ●各種サイズそろえています。
Feature ●ステンレス製は耐食性に優れています。
- Can be used various sizes
 ●Stainless steel pin has excellent corrosion-resistance.

材 質 ●B-80/鉄(SS)
 SB-80/ステンレス(SUS304)

表面処理 ●B-80/三価クロメートめっき

用 途 ●各種蝶番軸等

Material ●B-80/Rolled steel (SS)
 SB-80/Stainless steel (SUS304)

Finish ●B-80/Trivalent chromate plating

Specific Use ●Various shaft of hinges, etc.

品 番 Product No.		φD ₁	φD ₂	L ₁	T	製品自重(g) Weight		単 価 Price	
SS	SUS					SS	SUS	SS	SUS
B-80-1	SB-80-1	10	16	115	3	73.2	73.3	¥100	¥220
B-80-2	SB-80-2	8	14	130	3	53.4	53	¥80	¥200
B-80-3	SB-80-3	8	14	115	3	48	48.4	¥70	¥160
B-80-4	SB-80-4	8	14	110	3	46	45.7	¥60	¥160
B-80-5	SB-80-5	8	14	100	3	42	41.6	¥60	¥160
B-80-6	SB-80-6	8	14	85	3	36.5	36	¥55	¥150
B-80-7	SB-80-7	8	14	75	3	32.2	32	¥55	¥150
B-80-8	SB-80-8	6	11	110	2	25.3	25.3	¥40	¥130
B-80-9	SB-80-9	6	11	100	2	23.2	23.2	¥40	¥130
B-80-10	SB-80-10	6	11	90	2	21	21	¥35	¥110
B-80-11	SB-80-11	6	11	75	2	17.6	17.7	¥35	¥100
B-80-12	SB-80-12	6	11	65	2	15.5	15.7	¥32	¥100
B-80-13	SB-80-13	6	11	55	2	13.3	13.5	¥31	¥90
B-80-14	SB-80-14	5	9	110	3	17.8	17.8	¥40	¥120
B-80-15	SB-80-15	5	9	85	3	14.0	14.1	¥35	¥95
B-80-16	SB-80-16	5	9	80	3	13.2	13.2	¥35	¥90
B-80-17	SB-80-17	5	9	75	3	12.5	12.3	¥30	¥85
B-80-18	SB-80-18	5	9	65	3	10.9	11.0	¥30	¥85
B-80-19	SB-80-19	5	9	55	3	9.4	9.5	¥28	¥80
B-80-20	SB-80-20	4	8	67	3	7.3	7.2	¥25	¥80
B-80-21	SB-80-21	4	8	53	3	6.2	6.0	¥25	¥75
B-80-22	SB-80-22	4	8	33	3	4.1	4.0	¥25	¥75
B-80-23	SB-80-23	6	11	115	2	24.3	24.3	¥45	¥140
B-80-27	SB-80-27	8	14	90	3	38.5	38.0	¥55	¥160
B-80-28	SB-80-28	8	14	80	3	34.6	34.6	¥55	¥160
B-80-29	SB-80-29	7	13	85	3	28.0	28.4	¥50	¥160
B-80-30		6	11	85	2	20.0		¥35	
B-80-31	SB-80-31	6	11	70	2	16.7	16.4	¥32	¥100
B-80-32		6	11	60	2	14.4		¥32	
B-80-33	SB-80-33	6	11	45	2	11.1	11.3	¥32	¥90
B-80-34		6	11	35	2	8.8		¥32	
B-80-35	SB-80-35	5	9	45	3	8.1	7.8	¥25	¥75
B-80-36		5	9	35	3	6.6		¥25	
B-80-37	SB-80-37	4	8	60	3	6.9	6.7	¥25	¥80
B-80-38		4	8	43	3	5.2		¥25	
B-80-39	SB-80-39	4	8	28	3	3.7	3.6	¥25	¥75
B-80-40		4	8	23	3	3.2		¥25	

カラー・パイプ

COLLARS (PIPES)

B-90(ss)・SB-90(SUS)



B-90-19



B-90-24

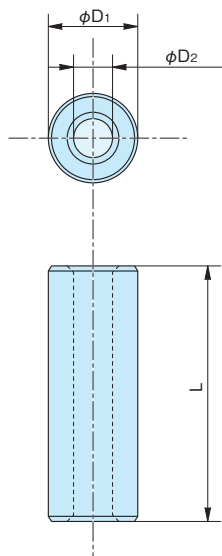

特 徴 Feature	<ul style="list-style-type: none"> ●各種サイズ別注品承ります。 ●Various sizes are available for special ordered products.
材 質	<ul style="list-style-type: none"> ●B-90/鉄(SS400) SB-90/ステンレス(SUS304)
Material	<ul style="list-style-type: none"> ●B-90/Rolled steel (SS400) SB-90/Stainless steel (SUS304)

品 番 Product No.		φD ₁	φD ₂	L	製品自重(g) Weight		単 価 Price	
SS	SUS				SS	SUS	SS	SUS
B-90-1	SB-90-1	10	5.1	30	13.1	13.6	¥45	¥180
B-90-2	SB-90-2	10	5.1	35	15.5	16	¥50	¥190
B-90-3	SB-90-3	12	5.1	15	10.6	10.7	¥40	¥140
B-90-4	SB-90-4	12	5.1	20	14.1	14.3	¥40	¥150
B-90-5	SB-90-5	12	5.1	30	21.1	21.6	¥50	¥190
B-90-6	SB-90-6	12	5.1	35	24.7	25.4	¥60	¥190
B-90-8	SB-90-8	12	6.1	40	25.8	27.5	¥70	¥230
B-90-9	SB-90-9	12	6.1	54	34.7	35.3	¥80	¥300
B-90-10	SB-90-10	14	6.1	20	19	19.3	¥40	¥160
B-90-11	SB-90-11	14	6.1	29	27.7	28.1	¥50	¥200
B-90-12	SB-90-12	14	6.1	40	38.8	39	¥70	¥270
B-90-13	SB-90-13	14	6.1	52	50.3	50.7	¥80	¥320
B-90-14		14	6.1	54	52.1		¥80	
B-90-15	SB-90-15	14	8.2	52	41	40.9	¥80	¥320
B-90-16	SB-90-16	14	8.2	54	42.7	42.2	¥80	¥340
B-90-17	SB-90-17	16	6.1	20	26.2	26.5	¥50	¥190
B-90-18	SB-90-18	16	6.1	52	69.6	70	¥95	¥370
B-90-19	SB-90-19	16	8.2	20	22.8	23.4	¥50	¥190
B-90-20	SB-90-20	16	8.2	52	59.1	59.9	¥95	¥370
B-90-21	SB-90-21	16	10.2	52	48	47.7	¥95	¥420
B-90-22	SB-90-22	16	10.2	54	49.9	50.4	¥95	¥440
B-90-23	SB-90-23	18	8.2	20	30.9	31.7	¥50	¥220
B-90-24	SB-90-24	18	8.2	50	78.4	78.4	¥100	¥400
B-90-25	SB-90-25	18	8.2	52	81.7	82	¥95	¥420
B-90-26	SB-90-26	18	10.2	24	31.7	32.2	¥65	¥230
B-90-27	SB-90-27	18	10.2	52	69.6	70	¥100	¥450
B-90-28	SB-90-28	19	8.2	20	35.6	36.5	¥70	¥230
B-90-29		19	8.2	52	93.6		¥160	
B-90-30		20	8.2	52	104		¥200	
B-90-32	SB-90-32	10	5.1	29	12.6	13.2	¥45	¥180
B-90-33	SB-90-33	12	6.1	20	12.6	12.9	¥40	¥150
B-90-34		12	5.1	40	28.1		¥75	
B-90-35	SB-90-35	12	6.1	42	26.0	27.3	¥60	¥240
B-90-36		12	6.1	52	33.4		¥85	
B-90-37	SB-90-37	13	5.1	20	17.1	17.4	¥70	¥160
B-90-38		13	5.1	30	25.7		¥70	
B-90-39	SB-90-39	16	8.2	29	32.6	33.7	¥60	¥270
B-90-40	SB-90-40	16	8.2	38	42.8	44.3	¥70	¥350
B-90-41	SB-90-41	16	6.1	40	52.4	54.0	¥80	¥350
	SB-90-42	20	8.2	20		41.0		¥260

角カラー

SQUARE COLLARS (PIPES)

B-91 (SS)・SB-91 (SUS)



B-91-3



B-91-6

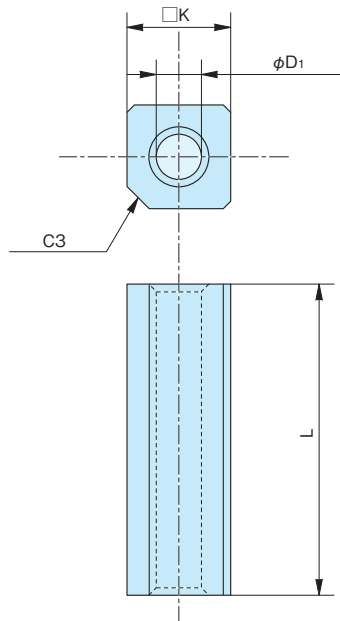

特 徴 ●各種サイズ別注品承ります。
Feature ●Various sizes are available for special ordered products.

材 質 ●B-91/鉄(SS400)
 SB-91/ステンレス(SUS304)

Material ●B-91/Rolled steel (SS400)
 SB-91/Stainless steel(SUS304)

品 番 Product No.		φD ₁	K	L	製品自重 (g) Weight		単 価 Price	
SS	SUS				SS	SUS	SS	SUS
	SB-91-0	5.2	12	15		13.7		¥200
B-91-1	SB-91-1	5.2	12	20	17.9	18.3	¥100	¥200
	SB-91-2-30	5.2	12	30		27.5		¥350
B-91-2	SB-91-2	5.2	12	35	31.3	32.2	¥120	¥350
B-91-3	SB-91-3	6.2	14	20	24.7	24.8	¥110	¥250
B-91-4	SB-91-4	6.2	14	42	52.3	52.2	¥140	¥430
B-91-40	SB-91-40	6.2	14	40	49.8	49.7	¥140	¥420
B-91-5	SB-91-5	8.2	16	20	30.3	30.6	¥130	¥300
B-91-6	SB-91-6	8.2	16	52	78.8	80.2	¥230	¥550
B-91-7	SB-91-7	8.2	18	20	39.9	41.4	¥170	¥450
B-91-8	SB-91-8	8.2	18	52	104.1	107.6	¥250	¥640
B-91-9	SB-91-9	10.2	18	52	92.1	95.9	¥260	¥660
	SB-91-10	10.2	18	24		44.1		¥380

スペーサー (ガス管)

SPACER PIPES

EG (SS)



EG8-20

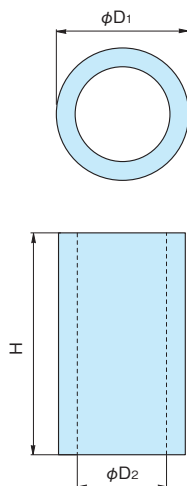

特 徴 ●機器取付時の空間の調整にご使用下さい。
Feature ●Can be used in adjusting space when mounting the equipments.

材 質 ●鉄 (SS)
表面処理 ●三価クロメートめっき

Material ●Rolled steel (ss)
Finish ●Trivalent chromate plating

品 番 Product No.	φD ₁	φD ₂	H	自 重 (g) Weight	単 価 Price
EG8-4.7	13.8	9.2	4.7	2.8	¥30
EG8-5.4	13.8	9.2	5.4	3.3	¥30
EG8-6.8	13.8	9.2	6.8	4.2	¥30
EG8-20	13.8	9.2	20	12.3	¥38
EG10-8.4	17.3	12.7	8.4	6.7	¥35
EG10-8.7	17.3	12.7	8.7	7	¥35
EG10-9.5	17.3	12.7	9.5	7.5	¥35
EG10-15	17.3	12.7	15	12	¥40
EG10-20	17.3	12.7	20	15.3	¥40
EG10-22	17.3	12.7	22	16.8	¥45
EG10-23	17.3	12.7	23	18.3	¥45
EG10-25	17.3	12.7	25	20.2	¥45
EG10-30	17.3	12.7	30	23.4	¥48
EG10-31	17.3	12.7	31	23.5	¥48
EG15-14	21.7	16.1	14	17.2	¥48
EG15-20	21.7	16.1	20	24.5	¥55
EG15-28	21.7	16.1	28	34	¥60
EG15-37	21.7	16.1	37	45.7	¥70
EG15-46	21.7	16.1	46	56.3	¥75
EG15-50	21.7	16.1	50	60.8	¥75

六角サポーター・絶縁六角サポーター



HEXAGONAL POSTS

EK(ss)・EKZ(ss)



EK-430



EK-650

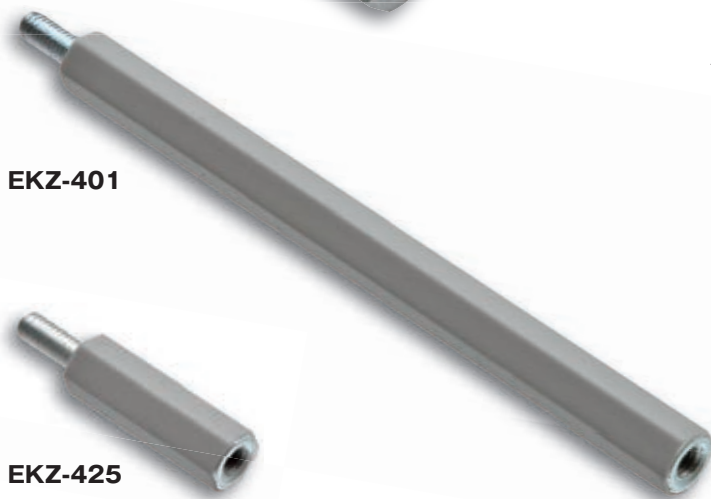

EKZ-401



EKZ-425

特徴 ●各種サイズをとりそろえています。
Feature ●Various sizes are available.

材質 ●鉄(SS)
●絶縁チューブ/ポリオレフィン
表面处理 ●三価クロメートめっき
●EKZ/絶縁チューブ付

Material ●Rolled steel (SS)
●Insulating tube/Polyorefin
Finish ●Trivalent chromate plating
●EKZ/With insulating tube

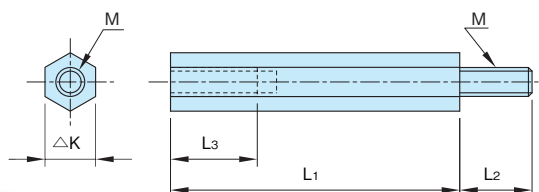

品番 Product No.	M	L ₁	L ₂	L ₃	ΔK	自重(g) Weight	入数 Lot	単価 Price
EK-310	3	10	6	6	6	2.1	100	¥45
EK-315	3	15	8	10	6	3.2	100	¥45
EK-320	3	20	8	10	6	4.5	100	¥50
EK-325	3	25	8	10	6	5.8	100	¥50
EK-330	3	30	8	10	6	6.8	100	¥55
EK-340	3	40	8	10	6	9	100	¥55
EK-420	4	20	10	12	7	5.8	100	¥55
EK-425	4	25	10	12	7	7.5	100	¥55
EK-430	4	30	10	12	7	9.1	100	¥60
EK-440	4	40	10	12	7	12.4	100	¥65
EK-450	4	50	10	12	7	15.5	100	¥70
EK-460	4	60	10	12	7	19	100	¥75
EK-401	4	100	10	12	7	32.2	100	¥85
EK-520	5	20	10	12	8	7.6	100	¥60
EK-525	5	25	10	12	8	9.6	100	¥60
EK-530	5	30	10	12	8	11.9	100	¥65
EK-540	5	40	10	12	8	16.2	100	¥70
EK-550	5	50	10	12	8	20.4	100	¥75

品番 Product No.	M	L ₁	L ₂	L ₃	ΔK	自重(g) Weight	入数 Lot	単価 Price
EK-560	5	60	10	12	8	24.6	100	¥80
EK-580	5	80	10	12	8	33.4	100	¥90
EK-501	5	100	10	12	8	41.9	100	¥100
EK-620	6	20	15	16	10	12.3	100	¥65
EK-625	6	25	15	16	10	15.2	100	¥70
EK-630	6	30	15	16	10	18.8	100	¥75
EK-640	6	40	15	16	10	25.3	100	¥80
EK-650	6	50	15	16	10	32.5	100	¥85
EK-660	6	60	15	16	10	38.6	100	¥95
EK-680	6	80	15	16	10	52.3	50	¥105
EK-601	6	100	15	16	10	65.5	50	¥120
EKZ-420	4	20	10	12	7	6.0	100	¥80
EKZ-425	4	25	10	12	7	7.7	100	¥80
EKZ-430	4	30	10	12	7	9.3	100	¥80
EKZ-440	4	40	10	12	7	12.9	100	¥90
EKZ-450	4	50	10	12	7	16.0	100	¥100
EKZ-460	4	60	10	12	7	19.5	100	¥100
EKZ-401	4	100	10	12	7	32.7	100	¥115

丸型サポーターEO・絶縁丸サポーターEOZ



ROUND POSTS-INSULATED ROUND POSTS

EO(ss)・EOZ(ss)

特 徴 ●丸型サポーターにヒシチューブの被覆を施した絶縁仕様の物もあります。
Feature ●The round posts which is covered with hisi-tube are also available.

材 質 ●鉄(SS)
 ●絶縁チューブ/ポリオレフィン
表面処理 ●三価クロメートめっき
 ●EOZ/絶縁チューブ付

Material ●Rolled steel (SS)
 ●Insulating tube/Polyolefin

Finish ●Trivalent chromate plating
 ●EOZ/With insulating tube

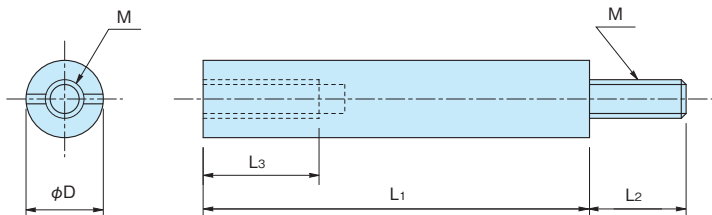

品番 Product No.	M	L ₁	L ₂	L ₃	φD	自重(g) Weight	入数 Lot	単価 Price
EO-420	4	20	10	12	8	7	100	¥60
EO-425	4	25	10	12	8	9	100	¥60
EO-430	4	30	10	12	8	10.9	100	¥65
EO-440	4	40	10	12	8	14.6	100	¥70
EO-450	4	50	10	12	8	18.5	100	¥75
EO-460	4	60	10	12	8	22.6	100	¥80
EO-401	4	100	10	12	8	38.2	100	¥90
EO-520	5	20	13	15	10	11.1	100	¥65
EO-525	5	25	13	15	10	14.2	100	¥70
EO-530	5	30	13	15	10	17.1	100	¥70
EO-540	5	40	13	15	10	22.9	100	¥80
EO-550	5	50	13	15	10	29.2	100	¥80
EO-560	5	60	13	15	10	35.3	100	¥85
EO-580	5	80	13	15	10	47.6	100	¥100
EO-501	5	100	13	15	10	59.9	50	¥110
EO-620	6	20	15	16	11	13.6	100	¥70
EO-625	6	25	15	16	11	17.2	100	¥70
EO-630	6	30	15	16	11	20.5	100	¥75
EO-640	6	40	15	16	11	28.2	100	¥85
EO-650	6	50	15	16	11	35	100	¥90
EO-660	6	60	15	16	11	42.6	100	¥95
EO-680	6	80	15	16	11	57.7	50	¥110
EO-601	6	100	15	16	11	72.7	50	¥125

品番 Product No.	M	L ₁	L ₂	L ₃	φD	自重(g) Weight	入数 Lot	単価 Price
EOZ-420	4	20	10	12	8	7.2	100	¥70
EOZ-425	4	25	10	12	8	9.1	100	¥70
EOZ-430	4	30	10	12	8	11.1	100	¥75
EOZ-440	4	40	10	12	8	14.9	100	¥80
EOZ-450	4	50	10	12	8	19.5	100	¥90
EOZ-460	4	60	10	12	8	23.1	100	¥95
EOZ-401	4	100	10	12	8	38.7	100	¥120
EOZ-520	5	20	13	15	10	11.2	100	¥80
EOZ-525	5	25	13	15	10	14.3	100	¥85
EOZ-530	5	30	13	15	10	17.4	100	¥85
EOZ-540	5	40	13	15	10	23.5	100	¥95
EOZ-550	5	50	13	15	10	30	100	¥100
EOZ-560	5	60	13	15	10	36	100	¥105
EOZ-580	5	80	13	15	10	48.4	100	¥125
EOZ-501	5	100	13	15	10	60.9	50	¥140
EOZ-620	6	20	15	16	11	13.8	100	¥80
EOZ-625	6	25	15	16	11	17.3	100	¥85
EOZ-630	6	30	15	16	11	20.9	100	¥90
EOZ-640	6	40	15	16	11	28.6	100	¥100
EOZ-650	6	50	15	16	11	36	100	¥110
EOZ-660	6	60	15	16	11	43.5	50	¥120
EOZ-680	6	80	15	16	11	58.3	50	¥140
EOZ-601	6	100	15	16	11	73.3	50	¥160

絶縁丸サポーター(+)

INSULATED ROUND POSTS(+)



EOZ(+)



EOZ-1420



EOZ-1450

特徴
Feature

- 先端が+字になっており、各種ドライバーで取り付け可能です。
- It can be mounted in a variety of drivers because of plus-shaped tip.

材質
Material

- 鉄(SS)
- 絶縁チューブ/ポリオレフィン

表面処理
Finish

- 三価クロメートめっき・絶縁チューブ付
- Traivalent chromate With insulating tube

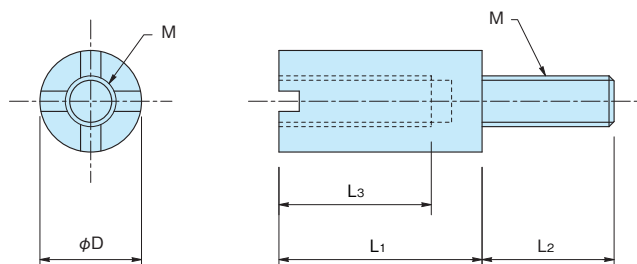

品番 Product No.	M	L ₁	L ₂	L ₃	φD	自重(g) Weight	入数 Lot	単価 Price
EOZ-1420	4	20	10	12	8	7.2	100	¥80
EOZ-1425	4	25	10	12	8	9.1	100	¥80
EOZ-1430	4	30	10	12	8	11.1	100	¥85
EOZ-1440	4	40	10	12	8	14.9	100	¥90
EOZ-1450	4	50	10	12	8	19.5	100	¥100
EOZ-1460	4	60	10	12	8	23.1	100	¥110
EOZ-1401	4	100	10	12	8	38.7	100	¥130

ローレットビス

KNURLED KNOBS

K-1(BS)



K-1-1

材質 ●K-1/黄銅棒
 表面処理 ●クロムめっき
 用途 ●配電盤・分電盤・制御盤・工作機械等
 備考 ●ナイロンワッシャー付

Material ●Brass bar (BS)
 Finish ●Chrome plating
 Specific Use ●Distribution, control boards, Machine tools, etc.
 Remarks ●Nylon washer is included.

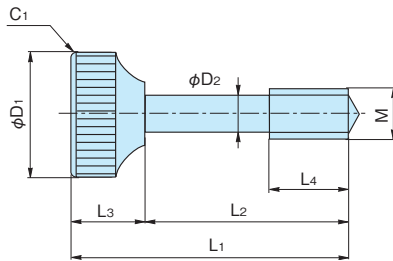

品番 Product No.	L ₁	L ₂	L ₃	L ₄	φD ₁	φD ₂	M	製品自重 (g) Weight	入数 Lot	単価 Price
K-1-1	55	44	11	20	22	6	8	38.9	50	¥380
K-1-2	45	34	11	15	22	6	8	39	100	¥340
K-1-3	45	36	9	15	18	4.8	6	20.5	100	¥270
K-1-4	35	26	9	10	16	4.8	6	16.7	100	¥210
K-1-5	30	21	9	10	16	4.8	6	16	100	¥200
K-1-6	45	37	8	15	15	4	5	14.4	100	¥210
K-1-7	35	27	8	10	15	4	5	12.8	100	¥200
K-1-8	30	22	8	10	15	4	5	12.7	100	¥190
K-1-9	35	27	8	10	14	3	4	10.3	100	¥180
K-1-10	28	20	8	10	14	3	4	10	100	¥170
K-1-11	60	47	13	20	20	6	8	40.6	100	¥350
K-1-12	55	42	13	20	20	4.8	6	34.1	100	¥330
K-1-13	23	15	8	5	14	3	4	9.7	100	¥160
K-1-14	18	10	8	4	14	3	4	9.1	100	¥160

ローレットビス

KNURLED KNOBS

K-3(BS)・SK-3(SUS)

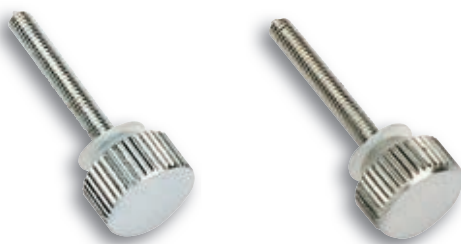

K-3-1

SK-3-1

特徴 ●全ネジ仕様になっています。
 Feature ●Whole screw type.

材質 ●K-3/黄銅棒
 ●SK-3/ステンレス(SUS303)
 表面処理 ●K-3/クロムめっき
 用途 ●配電盤・分電盤・制御盤・工作機械等
 備考 ●ナイロンワッシャー付

Material ●K-3/Brass bar (BS)
 ●SK-3/Stainless steel (SUS303)
 Finish ●K-3/Chrome plating
 Specific Use ●Distribution, control boards, Machine tools, etc.
 Remarks ●Nylon washer is included.

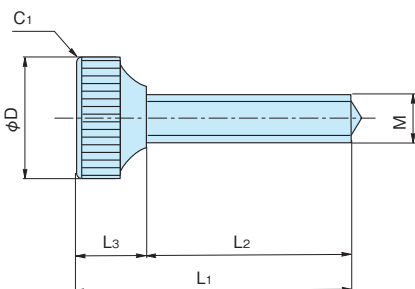

品番 Product No.		L ₁	L ₂	L ₃	φD	M	製品自重 (g) Weight		入数 Lot	単価 Price	
BS	SUS						BS	SUS		BS	SUS
K-3-1	SK-3-1	28	20	8	11	3	6.1	5.7	100	¥130	¥300
K-3-2	SK-3-2	30	20	10	16	4	14.4	13.2	100	¥190	¥370
K-3-3	SK-3-3	30	20	10	16	5	15.2	14.7	100	¥190	¥410
K-3-4	SK-3-4	30	20	10	16	6	16.3	16.8	100	¥190	¥380
K-3-5	SK-3-5	37	25	12	20	6	30.3	29.5	100	¥260	¥460
K-3-6	SK-3-6	37	25	12	20	8	34.1	32.9	100	¥260	¥520

ローレットビス

KNURLED KNOBS

K-2(BS)・SK-2(SUS)



K-2-1

SK-2-1

- 材 質 ●K-2/黄銅棒
●SK-2/ステンレス(SUS303)
表面処理 ●K-2/クロムめっき
用 途 ●配電盤・分電盤・制御盤・工作機械等
備 考 ●ナイロンワッシャー付

- Material ●K-2/Brass bar (BS)
●SK-2/Stainless steel (SUS303)
Finish ●K-2/Chrome plating
Specific Use ●Distribution, control boards, Machine tools, etc.
Remarks ●Nylon washer is included.

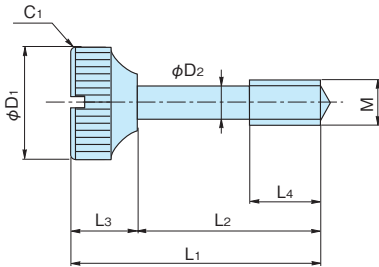

品番 Product No.		L ₁	L ₂	L ₃	L ₄	φD ₁	φD ₂	M	製品自重(g) Weight		入数 Lot	単価 Price	
BS	SUS								BS	SUS		BS	SUS
K-2-0	SK-2-0	61	50	11	20	22	6	8	41	41	50	¥420	¥840
K-2-1	SK-2-1	55	44	11	20	22	6	8	40.2	36.3	50	¥390	¥740
K-2-2	SK-2-2	45	34	11	15	22	6	8	37.5	35.4	100	¥350	¥690
K-2-3	SK-2-3	45	36	9	15	18	4.8	6	20.9	20.1	100	¥270	¥510
K-2-3L	SK-2-3L	59	50	9	20	18	4.8	6	24	24	100	¥330	¥650
K-2-4	SK-2-4	35	26	9	10	16	4.8	6	15.9	14.6	100	¥220	¥370
K-2-5	SK-2-5	30	21	9	10	16	4.8	6	15.2	14.3	100	¥220	¥360
K-2-6	SK-2-6	45	37	8	15	15	4	5	13.2	12.4	100	¥220	¥460
K-2-7	SK-2-7	35	27	8	10	15	4	5	12.1	11.6	100	¥200	¥360
K-2-8	SK-2-8	30	22	8	10	15	4	5	11.5	11.8	100	¥190	¥350
K-2-9	SK-2-9	35	27	8	10	14	3	4	9.8	9.2	100	¥190	¥350
K-2-10	SK-2-10	28	20	8	10	14	3	4	9.4	8.9	100	¥180	¥340
K-2-11	SK-2-11	60	47	13	20	20	6	8	39.6	37.6	100	¥360	¥620
K-2-12	SK-2-12	55	42	13	20	20	4.8	6	33	30.6	100	¥340	¥690
K-2-13	SK-2-13	23	15	8	5	14	3	4	9.1	8.4	100	¥170	¥300
K-2-14	SK-2-14	18	10	8	4	14	3	4	8.3	8.1	100	¥170	¥310

ローレットビス

KNURLED KNOBS

K-4(BS)・SK-4(SUS)



K-4

SK-4

- 材 質 ●K-4/黄銅棒
●SK-4/ステンレス(SUS303)
表面処理 ●K-4/クロムめっき
用 途 ●配電盤・分電盤・制御盤・工作機械等
備 考 ●ナット、スプリングワッシャー付

- Material ●K-4/Brass bar (BS)
●SK-5/Stainless steel (SUS303)
Finish ●K-4/Chrome plating
Specific Use ●Distribution, control boards, Machine tools, etc.
Remarks ●Nylon washer is included.

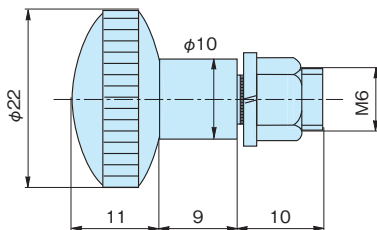

品番 Product No.	自重(g) Weight	入数 Lot	単価 Price
K-4	37	100	¥300
SK-4	34	100	¥520

脱落ビス

DROPOUT PREVENTIVE SCREWS



K-5(SS)



K-5-540-1

K-5-530-2

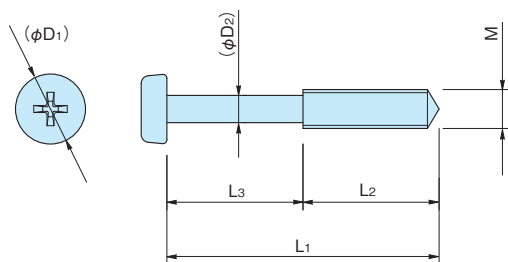

材質 ●鉄(SS)
 表面処理 ●生地と三価クロメートを用意しておりますので、ご指定ください。
 用途 ●配電盤・分電盤・制御盤・工作機械等
 備考 ●生地と三価クロメート以外の表面処理も承りますので、ご用命ください

Material ●Rolled steel(SS)
 Finish ●Trivalent chromate and non-plating are also available. Please specify.
 Specific Use ●Distribution, control boards, machine tools, etc.
 Remarks ●The other surface treatments are available besides trivalent chromate and non-plating. Please specify.

品番 Product No.	備考 Remarks	(φD1)	(φD2)	L1	L2	L3	M	自重(g) Weight	単価 Price						
K-5-415-1	生地	7	2.9	15	10	5	4	1.6	¥65						
K-5-415-2	三価クロメート							1.6	¥80						
K-5-420-1	生地							20	10	10	2.0	¥65			
K-5-420-2	三価クロメート										2.0	¥80			
K-5-425-1	生地										25	15	10	2.3	¥65
K-5-425-2	三価クロメート													2.3	¥80
K-5-430-1	生地			30	15	15								2.6	¥70
K-5-430-2	三価クロメート													2.6	¥85
K-5-435-1	生地							35	15	20				3.0	¥70
K-5-435-2	三価クロメート													3.0	¥85
K-5-440-1	生地										40	20	20	3.4	¥70
K-5-440-2	三価クロメート													3.4	¥85

品番 Product No.	備考 Remarks	(φD1)	(φD2)	L1	L2	L3	M	自重(g) Weight	単価 Price						
K-5-515-1	生地	9	3.8	15	10	5	5	2.6	¥65						
K-5-515-2	三価クロメート							2.6	¥80						
K-5-520-1	生地							20	10	10	3.0	¥65			
K-5-520-2	三価クロメート										3.0	¥80			
K-5-525-1	生地										25	15	10	3.7	¥65
K-5-525-2	三価クロメート													3.7	¥80
K-5-530-1	生地			30	15	15								4.0	¥70
K-5-530-2	三価クロメート													4.0	¥85
K-5-535-1	生地							35	15	20				4.5	¥70
K-5-535-2	三価クロメート													4.5	¥85
K-5-540-1	生地										40	20	20	5.0	¥70
K-5-540-2	三価クロメート													5.0	¥85

封印ビス

SEALING SCREWS



K-7(BS)



K-7

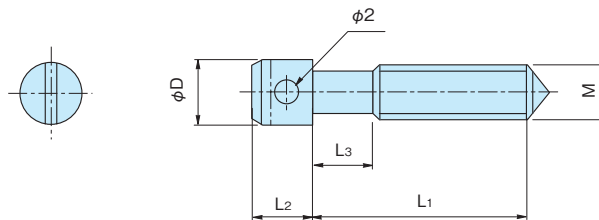

材質 ●K-7/黄銅棒
 表面処理 ●K-7/ニッケルめっき
 Material ●K-7/Brass bar (BS)
 Finish ●K-7/Nickel plating

品番 Product No.	L1	L2	L3	φD	M×ピッチ pitch	製品自重(g) Weight	入数 Lot	単価 Price
K-7-1	20	5.5	5.5	6	M5×0.8	4.2	100	¥50
K-7-2	16	5.5	5.5	6	M5×0.8	4	100	¥50
K-7-3	10	5.5	4	6	M5×0.8	2.8	100	¥45
K-7-4	20	5	5.5	5	M4×0.7	2.3	100	¥50
K-7-5	16	5	5.5	5	M4×0.7	2.1	100	¥50
K-7-6	10	5	3	5	M4×0.7	1.2	100	¥40

ローレットビス

KNURLED KNOBS

KP-9(BS)



品番 Product No.	φD ₁	L ₁	L ₂	L ₃	L ₄	M	自重(g) Weight	単価 Price
KP-9-1	17	14	18	12	30	6	15	¥350
KP-9-2	17	14	25	15	40	6	14	¥390
KP-9-3	17	14	15	15	30	8	21	¥350
KP-9-4	20	16	18	12	30	8	23	¥390
KP-9-5	20	16	25	15	40	8	26	¥450
KP-9-6	25	16	18	12	30	8	24	¥400
KP-9-7	25	16	25	15	40	8	28	¥470
KP-9-8	30	19	18	12	30	8	32	¥410
KP-9-9	30	19	23	12	35	8	34	¥400
KP-9-10	30	19	25	15	40	8	32	¥460
KP-9-11	17	14	15	10	25	6	11	¥350
KP-9-12	25	16	15	10	25	8	24	¥450
KP-9-13	25	16	20	15	35	8	27	¥470
KP-9-14	30	19	20	15	35	8	34	¥470
KP-9-16	30	19	30	15	45	8	34	¥460
KP-9-17	30	19	30	20	50	8	39	¥480

- 材質 ● 頭部/耐燃性ABS樹脂
● ネジ部/黄銅棒
- 表面処理 ● ニッケルめっき
- 用途 ● 配電盤・分電盤・操作盤・工作機械・船舶関係等
- 備考 ● ゴムワッシャ(5t)、ナイロンワッシャ(1.5t)、黄銅ワッシャ(2t)
● ワッシャのセットとバラがありますのでご指定ください。

- Material ● Head/Flame-resistant ABS resin
● Screw/Brass bar
- Finish ● Nickel plating
- Specific Use ● Distribution, control boards, Machine tools, etc.
- Remarks ● Rubber washer(5t), nylon washer(1.5t), brass washer(2t)
● Set or separation of washer are available. Please specify.

KP-9-1~3・KP-9-11

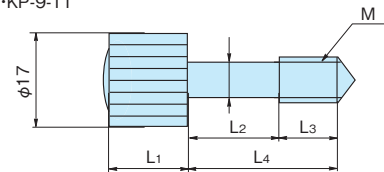

KP-9-4~10・KP-9-12~17

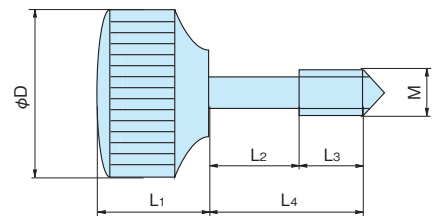

ローレットビス

KNURLED KNOBS

KP-6(SS)



KP-6-2

- 材質 ● 頭部/ユリア樹脂
● ネジ部/鉄(SS)
- 表面処理 ● 三価クロメートめっき
- 用途 ● 配電盤・分電盤・制御盤・工作機械等
- 備考 ● ナイロンワッシャー、鉄ワッシャー付

- Material ● Head/Urea resin
● Screw/Rolled steel (SS)
- Finish ● Trivalent chromate plating
- Specific Use ● Distribution, control boards, Machine tools, etc.
- Remarks ● Nylonwasher and Steelwasher are included.

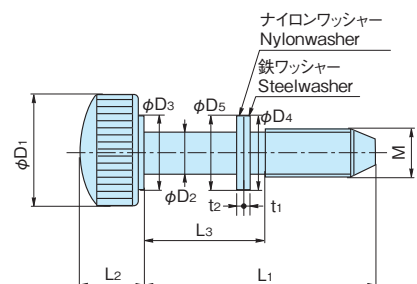

品番 Product No.	L ₁	L ₂	L ₃	φD ₁	φD ₂	φD ₃	φD ₄	φD ₅	t ₁	t ₂	M	製品自重(g) Weight	入数 Lot	単価 Price
KP-6-3	48	18	30	30	6	16	13	16	3	1	8	40.8	50	¥460
KP-6-4	38	18	20	30	6	16	13	16	3	1	8	38.4	50	¥370
KP-6-5	28	18	10	30	6	16	13	16	3	1	8	36.6	50	¥360

※市販品につき、ケース単位(入数)でのご注文をお願い致します。(※Please order in case unit(Quantity) about products on the market.)

ローレットビス(十字穴付)

KNURLED KNOBS (CROSS RECESSED HEAD)

SK-17(SUS)



SK-17

- 特 徴**
Feature
- 頭に十字穴がついていますので、プラスドライバーで締め込みができます。
 - ステンレス製で耐食性に優れています。
 - It can be tightened by phillips head screwdriver because of cross recessed head.
 - It has a high resistance to corrosion because of stainless steel.

- 材 質** ●ステンレス(SUS)
表面処理 ●鏡面バフ研磨
付 属 品 ●ナイロンワッシャ
用 途 ●配電盤・分電盤・制御盤・工作機械等

Material Stainless steel (SUS303)
Finish Mirror surface buffing
Accessories Nylon washer
Specific Use Distribution, control boards, machine tools, etc

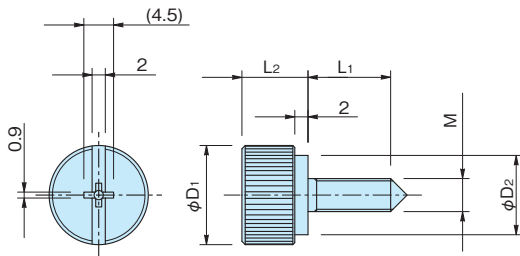

品 番 Product No.	L ₁	L ₂	φD ₁	φD ₂	M	製品自重(g) Weight	単 価 Price
SK-17-1	12	12	18	12	6	23.5	¥350
SK-17-2	7	12	18	12	6	22.5	¥330
SK-17-3	12.5	10	15	12	5	14	¥300
SK-17-4	7.5	10	15	12	5	13.5	¥280
SK-17-5	13	10	15	10	4	12.8	¥290
SK-17-6	8	10	15	10	4	12.5	¥270
SK-17-7	10.5	8	12	8	3	6	¥230
SK-17-8	6.5	8	12	8	3	5.9	¥230

ローレットビス

KNURLED KNOBS

K-8(BS)

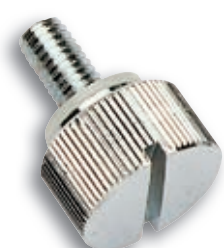

K-8-1

- 材 質** ●K-8/黄銅(BS)
表面処理 ●クロムめっき
用 途 ●配電盤・分電盤・制御盤・工作機械等
備 考 ●ナイロンワッシャー付

Material ●K-8/Brass bar (BS)
Finish ●Chrome plating
Specific Use ●Distribution, control boards, Machine tools, etc.
Remarks ●Nylon washer is included.

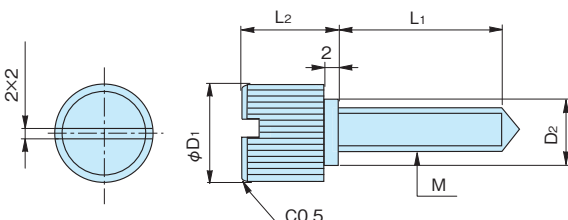

品 番 Product No.	L ₁	L ₂	φD ₁	φD ₂	M	製品自重(g) Weight	入 数 Lot	単 価 Price
K-8-1	12	12	18	12	6	24.3	100	¥210
K-8-2	7	12	18	12	6	23.4	100	¥190
K-8-3	12.5	10	15	12	5	17.4	100	¥180
K-8-4	7.5	10	15	12	5	13.9	100	¥170
K-8-5	13	10	15	10	4	13.5	100	¥180
K-8-6	8	10	15	10	4	13.1	100	¥170
K-8-7	10.5	8	12	8	3	6.4	100	¥150
K-8-8	6.5	8	12	8	3	6.3	100	¥150

取手

PULLS

K-30(SS)・SK-30(SUS)



K-30-3



座金・ナット・スプリングW
Washer·nut·spring washer

- 材 質 ●K-30/鉄(SS)
●SK-30/ステンレス(SUS304)
表面処理 ●K-30/パフクロムめっき
用 途 ●各種機器、設備等
備 考 ●座金・ナット・スプリングワッシャー付

- Material ●K-30/Rolled steel (SS)
●SK-30/Stainless steel (SUS304)
Finish ●K-30/Buffering chrome finish
Specific Use ●Various equipments, facilities, etc.
Remarks ●Washer·nut·spring washer are included.

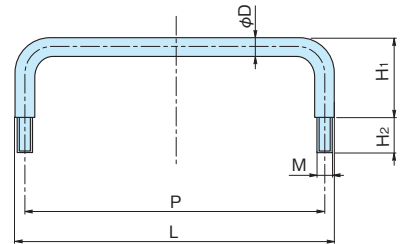

品 番 Product No.		L	P	H ₁	H ₂	φD	M	製品自重(g) Weight		入 数 Lot	単 価 Price	
SS	SUS							SS	SUS		SS	SUS
K-30-1	SK-30-1	300	288	50	20	12	8	331	336	50	¥770	¥1,300
K-30-2	SK-30-2	250	238	50	20	12	8	289	292	40	¥700	¥1,150
K-30-3	SK-30-3	200	188	50	20	12	8	246	248	40	¥620	¥1,100
K-30-4	SK-30-4	130	120	40	11	10	6	114	114	20	¥400	¥570
K-30-5	SK-30-5	120	110	40	11	10	6	107	108	30	¥400	¥550
K-30-6	SK-30-6	109	100	30	11	9	5	74	72	30	¥380	¥500
K-30-7	SK-30-7	75	68	30	11	7	5	37	36	50	¥350	¥430
K-30-8	SK-30-8	162	150	50	20	12	8	212	212	10	¥600	¥820

取手

PULLS

K-31(SS)・SK-31(SUS)



K-31-3

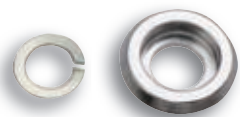

座金・スプリングW
Washer·spring washer

- 材 質 ●K-31/鉄(SS)
●SK-31/ステンレス(SUS304)
表面処理 ●K-31/パフクロムめっき
用 途 ●各種機器、設備等
備 考 ●座金・スプリングワッシャー付

- Material ●K-31/Rolled steel (SS)
●SK-31/Stainless steel (SUS304)
Finish ●K-31/Buffering chrome finish
Specific Use ●Various equipments, facilities, etc.
Remarks ●Washer·spring washer are included.

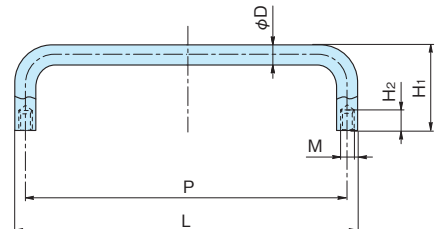

品 番 Product No.		L	P	H ₁	H ₂	φD	M	製品自重(g) Weight		入 数 Lot	単 価 Price	
SS	SUS							SS	SUS		SS	SUS
K-31-1	SK-31-1	300	288	50	20	12	8	304	306	50	¥750	¥1,250
K-31-2	SK-31-2	250	238	50	20	12	8	263	262	40	¥700	¥1,100
K-31-3	SK-31-3	200	188	50	20	12	8	216	218	40	¥620	¥950
K-31-4	SK-31-4	130	120	40	11	10	6	104	103	20	¥400	¥620
K-31-5	SK-31-5	120	110	40	11	10	6	99	99	30	¥400	¥610
K-31-6	SK-31-6	109	100	30	11	9	5	67	67	30	¥380	¥480
K-31-7	SK-31-7	75	68	30	11	7	5	30	30	50	¥350	¥420
K-31-8	SK-31-8	162	150	50	20	12	8	184	183	10	¥600	¥760

取手

PULLS

K-32(BS)



K-32

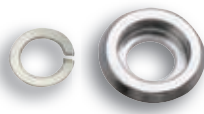

座金・スプリングW
Washer・spring washer

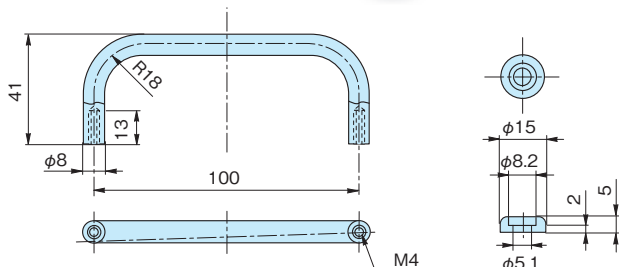

材質 ●K-32/黄銅棒
表面処理 ●バフクロムめっき
用途 ●各種機器、設備等
備考 ●座金・スプリングワッシャー付

Material ●Brass (BS)
Finish ●Buffing chrome finish
Specific Use ●Various equipments, facilities, etc.
Remarks ●Washer・spring washer are included.

品番 Product No.	自重(g) Weight	入数 Lot	単価 Price
K-32	67	40	¥460

取手

PULLS

K-33(SS)



K-33



座金・ナット・スプリングW
Washer・nut・spring washer

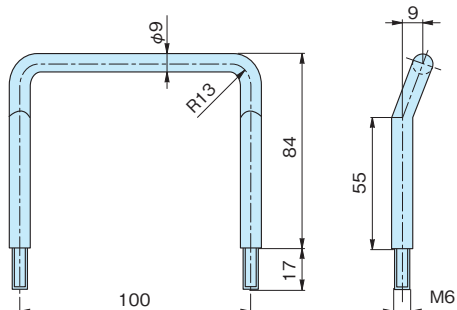

材質 ●K-33/鉄(SS)
表面処理 ●バフクロムめっき
用途 ●各種機器、設備等
備考 ●座金・ナット・スプリングワッシャー付

Material ●Rolled steel (SS)
Finish ●Buffing chrome finish
Specific Use ●Various equipments, facilities, etc.
Remarks ●Washer・nut・spring washer are included.

品番 Product No.	自重(g) Weight	入数 Lot	単価 Price
K-33	133	10	¥480

座金

WASHER

K-30-W (BS)・SK-30-W (SUS)

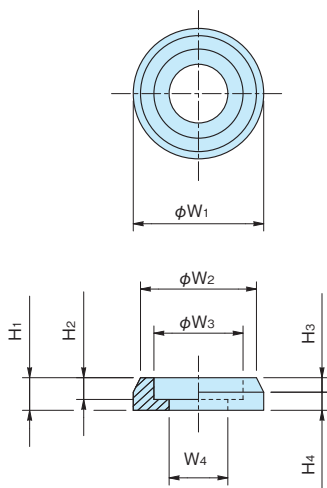

材質 ●K-30-W/黄銅(BS)
●SK-30-W/ステンレス(SUS303)
表面処理 ●K-30-W/クロムめっき
備考 ●取手等にSETしてご使用ください。
●1セット2個入り

Material ●K-30-W/Brass (BS)
●SK-30-W/Stainless steel (SUS303)
Finish ●K-30-W/Chrome plating
Remarks ●Please use the handle to set.
●Two pieces per set.

品番 Product No.	φW ₁	φW ₂	φW ₃	φW ₄	H ₁	H ₂	H ₃	H ₄	単価 (1SET=2個) Price
K-30-W-1	18	16	12.3	8.1	4.5	3	2	2.5	¥110
K-30-W-2	15	13	10.3	6.1	3.5	2	1.5	2	¥90
K-30-W-3	14	12	9.3	5.1	3	2	1	2	¥90
K-30-W-4	10	9	7.3	5.1	3	2	1	2	¥80
SK-30-W-1	18	16	12.2	8.1	4.5	3	2	2.5	¥140
SK-30-W-2	15	13	10.2	6.1	3.5	2	1.5	2	¥120
SK-30-W-3	14	12	9.2	5.1	3	2	1	2	¥120
SK-30-W-4	10	9	7.2	5.1	3	2	1	2	¥110

取手

PULLS

K-34(SS)・SK-34(SUS)



SK-34-3

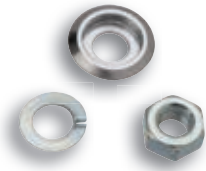

座金・ナット・スプリングW
Washer・nut・spring washer

- 材 質 ●K-34/鉄(SS)
●SK-34/ステンレス(SUS304)
表面処理 ●K-34/バフクロムめっき
用 途 ●各種機器、設備等
備 考 ●座金・ナット・スプリングワッシャー付

- Material ●K-34/Rolled steel (SS)
●SK-34/Stainless steel (SUS304)
Finish ●K-34/Buffering chrome finish
Specific Use ●Various equipments, facilities, etc.
Remarks ●Washer・nut・spring washer are included.

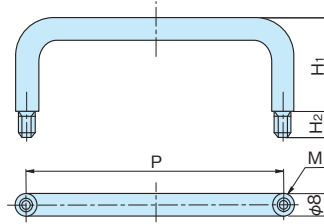

品 番 Product No.		P	M	H ₁	H ₂	製品自重 (g) Weight		入 数 Lot	単 価 Price	
SS	SUS					SS	SUS		SS	SUS
K-34-3	SK-34-3	80	5	30	16	52	52	40	¥340	¥520
K-34-4	SK-34-4	100	5	31	16	61	61	30	¥360	¥530
K-34-5	SK-34-5	100	5	35	10	62	62	30	¥350	¥530
K-34-6	SK-34-6	120	5	40	10	74	74	20	¥430	¥630
K-34-7	SK-34-7	150	5	40	16	88	88	20	¥430	¥650

取手

PULLS

K-35(SS)・SK-35(SUS)



SK-35-3



座金・スプリングW
Washer・spring washer

- 材 質 ●K-35/鉄(SS)
●SK-35/ステンレス(SUS304)
表面処理 ●K-35/バフクロムめっき
用 途 ●各種機器、設備等
備 考 ●座金・スプリングワッシャー付

- Material ●K-35/Rolled steel (SS)
●SK-35/Stainless steel (SUS304)
Finish ●K-35/Buffering chrome finish
Specific Use ●Various equipments, facilities, etc.
Remarks ●Washer・spring washer are included.

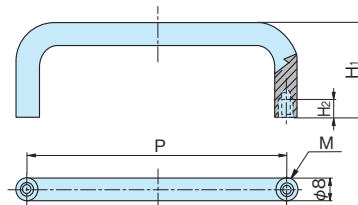

品 番 Product No.		P	M	H ₁	H ₂	製品自重 (g) Weight		入 数 Lot	単 価 Price	
SS	SUS					SS	SUS		SS	SUS
K-35-3	SK-35-3	80	5	30	12	45	43	40	¥340	¥520
K-35-4	SK-35-4	100	5	31	13	52	53	30	¥350	¥540
K-35-5	SK-35-5	100	5	35	10	57	56	30	¥350	¥540
K-35-6	SK-35-6	120	5	40	10	69	68	20	¥430	¥630
K-35-7	SK-35-7	150	5	40	13	80	79	20	¥430	¥650

取手

PULLS

K-36(SS)

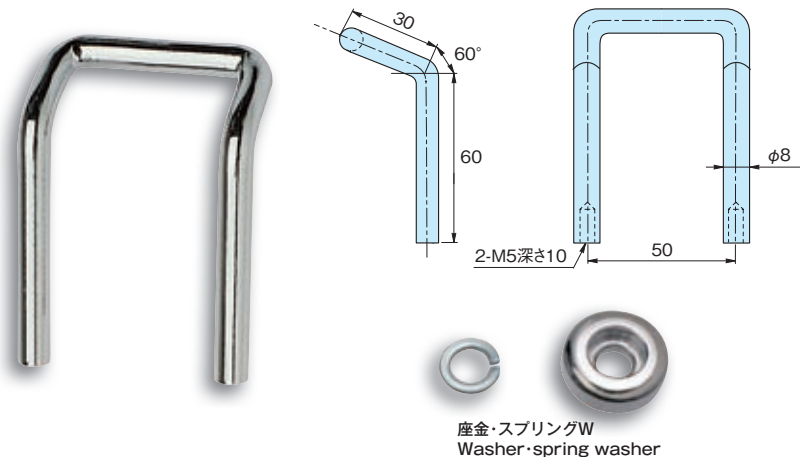

材質 ●K-36/鉄(SS)
表面処理 ●バフクロムめっき
用途 ●各種機器、設備等
備考 ●座金・スプリングワッシャー付

Material ●K-36/Rolled steel (SS)
Finish ●Buffing chrome finish
Specific Use ●Various equipments, facilities, etc.
Remarks ●Washer・spring washer are included.

品番 Product No.	自重(g) Weight	入数 Lot	単価 Price
K-36	80	20	¥500

取手

PULLS

K-37-2(ZDC)

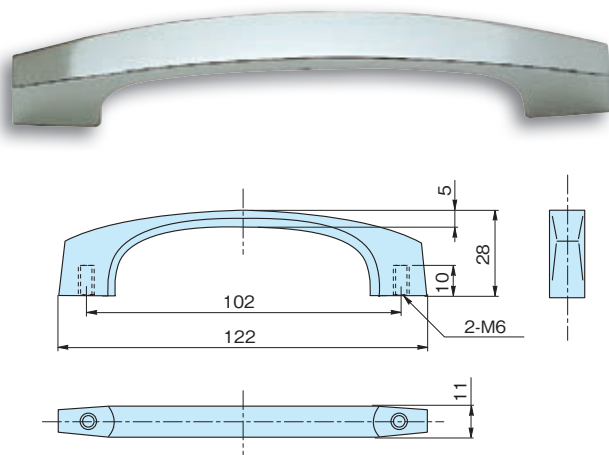

材質 ●亜鉛合金(ZDC)
表面処理 ●クロムめっき
用途 ●各種機器、設備等

Material ●Zinc alloy(ZDC)
Finish ●Chrome plating
Specific Use ●Various equipments, facilities, etc

品番 Product No.	自重(g) Weight	入数 Lot	単価 Price
K-37-2	67	50	¥260

樹脂取手

RESIGN HANDLE

KP-37-2~3

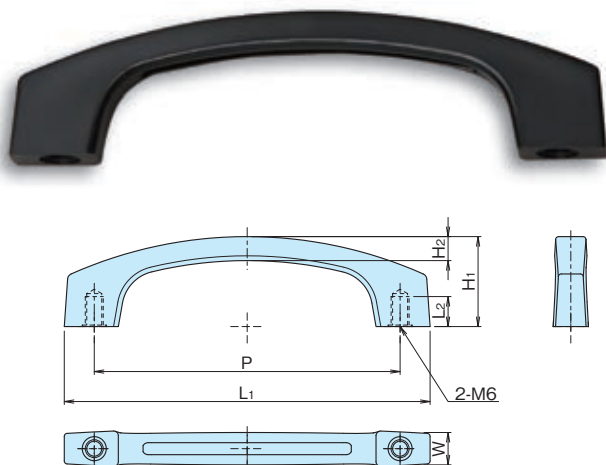

特徴 ●耐塩・絶縁性に優れています
Feature ●It has excellent salt tolerance and insulation properties.

材質 ●PC/ABSアロイ(UL94 V-0相当)
使用荷重 ●245N(25kgf)
標準色 ●ブラック
用途 ●各種機器、設備等
備考 ●常温でご使用ください

Material ●PC/ABS resin (Equivalent UL94 V-0)
Working load ●245N(25kgf)
Standard Color ●Black
Specific Use ●Various equipments, facilities, etc
Remarks ●Please use it at room temperature.

品番 Product No.	L1	L2	W	H1	H2	P	自重(g) Weight	入数 Lot	単価 Price
KP-37-2	122	10	11	30	8	102	15.8	50	¥100
KP-37-3	104	8	9	23	6	86	8.7	50	¥70

樹脂取手

RESIN PULLS

K-38

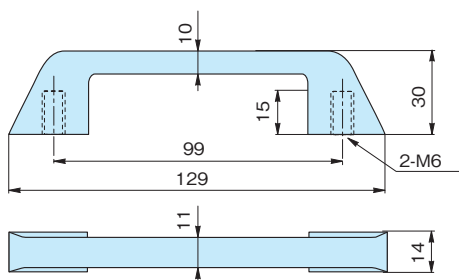

材質 ●樹脂ナイロン
色 ●黒・白
用途 ●各種機器・設備等

Material ●Nylon resin
Standard Color ●Black or White
Specific Use ●Various equipments, facilities, etc.

品番 Product No.	自重(g) Weight	入数 Lot	単価 Price
K-38	26	100	¥240

取手

PULLS

K-39(ZDC)・KP-39



K-39



KP-39

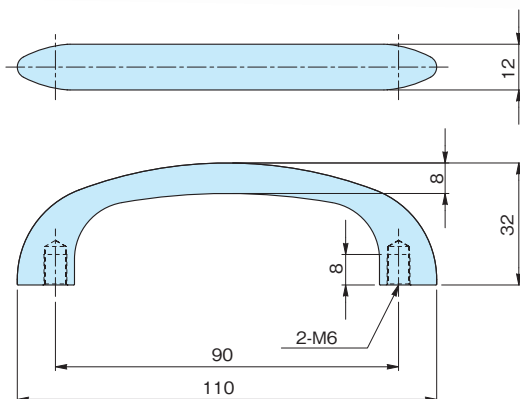

(K-39)

材質 ●亜鉛合金 (ZDC)
表面処理 ●クロムめっき
用途 ●計測機器・設備等

Material ●Zinc alloy (ZDC)
Finish ●Chrome plating
Specific Use ●Measuring equipments, etc.

(KP-39)

特徴 ●取付用ネジはインサート金具(黄銅製)を使用して強度をUPしています。
●Mounting screws in the bracket insert (Brass) have high strength.

材質 ●PC/ABSアロイ (UL94 V-0相当)
●インサート部/真鍮

標準色 ●ブラック
用途 ●計測機器・通信機器
備考 ●常温でご使用ください

Material ●PC/ABS alloy
●Insert part/Brass
Standard Color ●Black
Specific Use ●Measuring equipments, communication equipments
Remarks ●Please use at room temperature.

品番 Product No.	自重(g) Weight	入数 Lot	単価 Price
K-39	74	50	¥300
KP-39	17	50	¥140

ステンレス取手

STAINLESS PULLS

SK-43R(SUS)

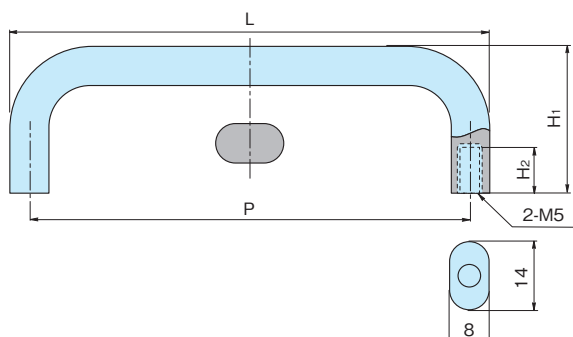

材質 ● ステンレス (SUS304)
備考 ● バフ研磨

Material ● Stainless steel (SUS304)
Finish ● Buffing

品番 Product No.	L	P	H ₁	H ₂	自重 (g) Weight	単価 Price
SK-43R-1	80	72	30	10	84	¥1,700
SK-43R-2	100	92	30	10	102	¥1,850
SK-43R-3	120	112	34	12	120	¥2,300
SK-43R-4	150	142	36	12	148	¥2,750
SK-43R-5	180	172	37	12	174	¥3,400
SK-43R-6	220	212	38	12	210	¥4,000
SK-43R-7	258	250	50	12	260	¥5,800

角型取手

SQUARE-TYPE PULLS

K-85-3(ZDC)

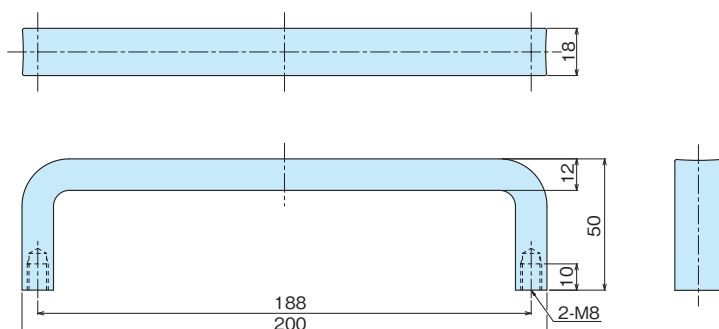

材質 ● 亜鉛合金 (ZDC)
表面処理 ● クロムめっき
用途 ● 各種筐体の扉

Material ● Zinc alloy (ZDC)

Finish ● Chrome plating

Specific Use ● The door of various equipments

品番 Product No.	自重 (g) Weight	単価 Price
K-85-3	273	¥1,200

取手

HANDRAILS

K-80



- 材 質 ●難燃性ポリエチレン
●インサート部/真鍮
●パイプ/鉄
- 用 途 ●配電盤:分電盤・船舶用BOX等
- 備 考 ●ミドルサポートをご入用の場合は、別途ご指定下さい。(K-80M)

- Material ●Flame-retarded polyethylene
●Insert section/Brass
●Pipe/Steel
- Specific Use ●Distribution boards, panels for marine vessel, etc.
- Remarks ●If the middle support is necessary, please specify separately. (K-80M)

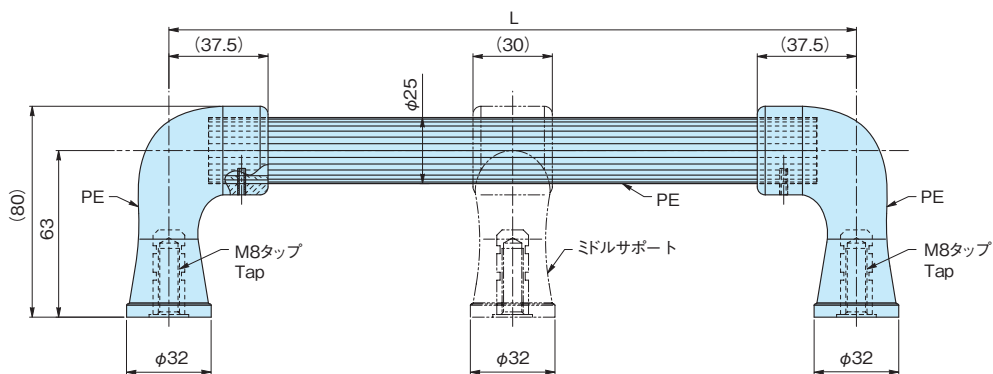

K-80M

品番 Product No.	L (mm)	自重(g) Weight	入数 Lot	単価 Price
K-80-1	320	394		¥1,450
K-80-2	370	436		¥1,550
K-80-3	470	537		¥1,650
K-80-4	570	600		¥1,800
K-80-5	670	690		¥1,950
K-80-6	770	764		¥2,100
K-80-7	870	864		¥2,200
K-80-8	970	944		¥2,350
K-80M		58		¥400

取手

MINI HANDRAILS

K-82



- 材 質 ●難燃性ポリエチレン
●インサート部/真鍮
●パイプ/鉄
- 用 途 ●配電盤・分電盤・船舶用BOX等

- Material ●Flame-retarded polyethylene
●Insert section/Brass
●Pipe/Steel

- Specific Use ●Distribution boards, panels for marine vessel, etc.

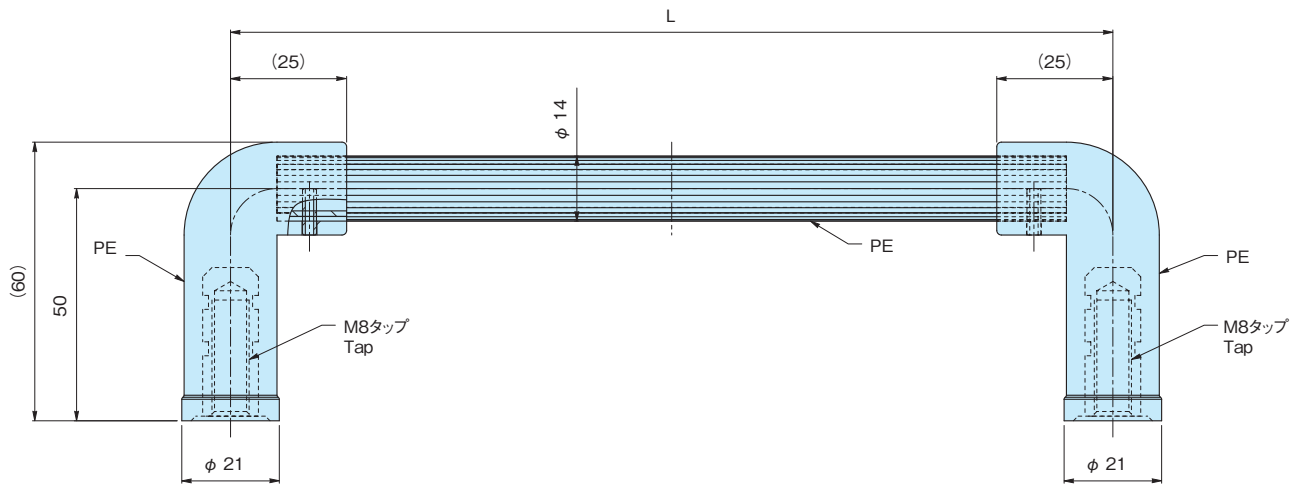

品番 Product No.	L (mm)	自重 (g) Weight	入数 Lot	単価 Price
K-82-1	140	122		¥940
K-82-2	190	136		¥970
K-82-3	240	158		¥990
K-82-4	290	174		¥1,000
K-82-5	340	192		¥1,050

ドアストッパ

DOOR STOPPERS

C-211 (ss)



特 徴 ●簡易型のストッパーです。
Feature ●Simple stopper type.

材 質 ●鉄(SS400)
表面処理 ●三価クロメート

Material ●Rolled steel (SS400)
Finish ●Trivalent chromate plating

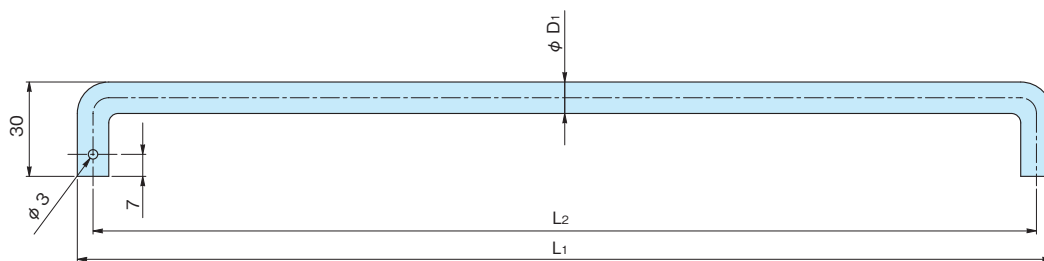

品 番 Product No.	ϕD_1	L_1	L_2	自重 (g) Weight	単 価 Price
C-211-1	10	210	200	147	¥240
C-211-2	10	260	250	178	¥250
C-211-3	10	310	300	209	¥270
C-211-4	8	158	150	76	¥210
C-211-5	8	208	200	96	¥220
C-211-6	8	258	250	116	¥230
C-211-7	8	308	300	135	¥240

アイボルト

EYE BOLTS

CB(ss)・SCB(sus)



CB-16



SCB-1650

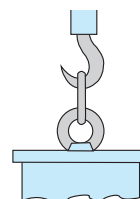
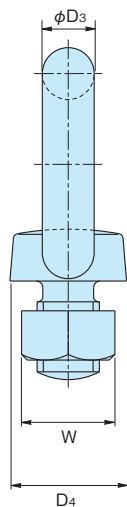
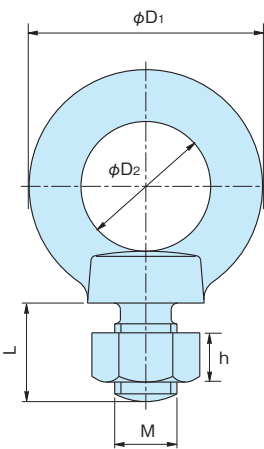

垂直つり
Vertical suspending

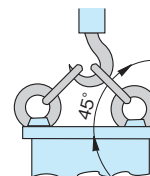

45度つり
45° suspending

- 材質**
- CB/鉄(SS)
 - SCB/ステンレス(SUS)
- 表面処理**
- CB/三価クロメートめっき
- 用途**
- 配電盤・分電盤・制御盤・工作機械等
- 備考**
- JIS B1168に準拠しています。
 - 製品の自重・単価はメッキ付・ナット付で掲載しております。
 - ステン製のナットは両面トリになっています。片面トリをご入用の時は別途ご指定下さい。
 - 六価クロメート・生地も承ります。

- Material**
- CB/Rolled steel (SS)
 - SCB/Stainless steel (SUS)
- Finish**
- CB/Trivalent chromate plating
- Specific Use**
- Distribution, control boards, machine tools, etc.
- Remarks**
- Conformity to JIS B1168
 - Nut and plating are included in the unit price and weight of the product.
 - Stainless steel nut is turned to C-face machining on both sides. If you need a C-face machining on one side, please specify.
 - Zin chromate plated and unplated are also available.

品番 Product No.		M	L	φD ₁	φD ₂	φD ₃	φD ₄	h	w	使用荷重 (Kgf) Weight	自重(g)		入数 Lot	単価 Price	
SS	SUS									SS	SUS	SS		SUS	
CB-8	SCB-8	8	15	32.5	20	6.3	16	6.5	13	80	39.5	38.3	500	¥100	¥260
CB-10	SCB-10	10	18	41	25.5	8	20	8	17	150	75.5	69.2	250	¥110	¥300
CB-12	SCB-12	12	22	50	30	10	25	10	19	220	136.6	132.5	180	¥150	¥480
	SCB-1227	12	27	50	30	10	25	10	19	220		133.2	185		¥700
CB-1230	SCB-1230	12	30	50	30	10	25	10	19	220	141.4	138	150	¥220	¥750
CB-1235		12	35	50	30	10	25	10	19	220	147.2		150	¥230	
CB-1240		12	40	50	30	10	25	10	19	220	149.6		150	¥230	
CB-1250	SCB-1250	12	50	50	30	10	25	10	19	220	155.5	149.5	150	¥230	¥780
CB-16	SCB-16	16	27	60	35	12.5	30	12.5	24	450	240.0	240.6	100	¥230	¥720
CB-1635	SCB-1635	16	35	60	35	12.5	30	12.5	24	450	260.2	247.9	100	¥360	¥1,290
CB-1640	SCB-1640	16	40	60	35	12.5	30	12.5	24	450	268.0	266	100	¥360	¥1,290
CB-1650	SCB-1650	16	50	60	35	12.5	30	12.5	24	450	275.0	269.8	80	¥330	¥1,150
CB-20	SCB-20	20	30	72	40	16	35	16	29.5	630	455.0	437.6	50	¥370	¥1,250
CB-2040		20	40	72	40	16	35	16	29.5	630	469.0		50	¥520	
CB-2050	SCB-2050	20	50	72	40	16	35	16	29.5	630	482.4	472.6	50	¥520	¥2,200
CB-22	SCB-22	22	34	81	44	18	40	18	31.3	750	631.4	607.3	40	¥540	¥2,750
CB-2250	SCB-2250	22	50	81	44	18	40	18	31.3	750	679.7	648.9	40	¥1,050	¥3,950
CB-24	SCB-24	24	38	90	50	20	45	18.5	35.3	950	888.0	858.3	25	¥840	¥2,500
CB-2450	SCB-2450	24	50	90	50	20	45	18.5	35.3	950	929.8	901.9	25	¥1,200	¥4,700
CB-2475		24	75	90	50	20	45	18.5	35.3	950	1000.0			¥1,500	
CB-24148		24	148	90	50	20	45	18.5	35.3	950	1238.0			¥2,000	
CB-30	SCB-30	30	45	110	60	25	60	24	45.5	1500	1729.0	1933.0	13	¥1,450	¥7,200
CB-3060		30	60	110	60	25	60	24	45.5	1500	1870.0		13	¥2,000	
CB-3660		36	60	133	70	31.5	70	29	55	2300	3280.0		8	¥4,700	

アイナット

EYE NUTS

CN(SS)・SCN(SUS)

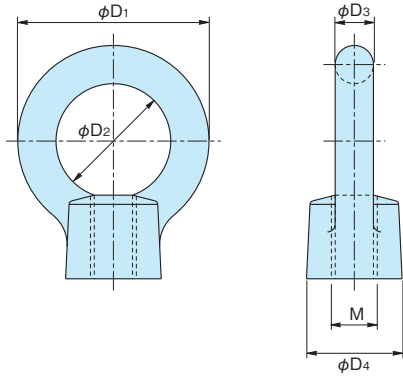

材質 ● CN/鉄 (SS)
● SCN/ステンレス (SUS)
表面処理 ● CN/三価クロメートめっき
用途 ● 配電盤・分電盤・制御盤・工作機械等
備考 ● JIS B1169に準拠しています。

Material ● CN/Rolled steel (SS)
● SCN/Stainless steel (SUS)
Finish ● CN/Trivalent chromate plating
Specific Use ● Distribution, control boards, machine tools, etc.
Remarks ● Conformity to JIS B1169

品番 Product No.		M	φD ₁	φD ₂	φD ₃	φD ₄	製品自重 (g) Weight		入数 Lot	単価 Price	
SS	SUS						SS	SUS		SS	SUS
CN-8	SCN-8	8	32.6	20	6.3	16	35	35	500	¥160	¥400
CN-10	SCN-10	10	41	25	8	20	64	66	250	¥170	¥430
CN-12	SCN-12	12	50	30	10	25	123	125	180	¥180	¥720
CN-16	SCN-16	16	60	35	12.5	30	216	204	100	¥270	¥1,050
CN-20	SCN-20	20	72	40	16	35	377	306	50	¥430	¥1,800
CN-22	SCN-22	22	80	44	18	40	563	527	40	¥800	¥2,000
CN-24	SCN-24	24	90	50	20	45	800	800	40	¥810	¥2,600

溶接ナット パイロット付

WELD NUTS WITH PILOT

BW(SS)

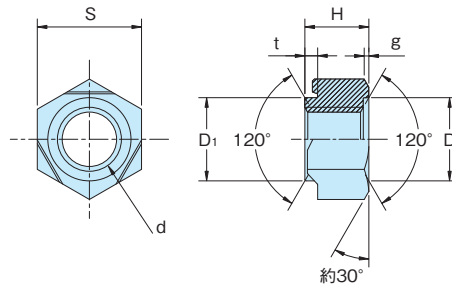

材質 ● 鉄 (SS)
表面処理 ● 生地
用途 ● タップを立てられない物に対して溶接して使用します。
備考 ● パイロット無し等もございますので、担当者にて確認して下さい。

Material ● Rolled steel (SS)
Finish ● Plain
Specific Use ● Can be welded and used for things can not tap.
Remarks ● Weld nuts without pilot are also available. Please consult us.

品番 Product No.	d ねじの呼び Nominal screw size	外形 Outline dimension				面取り Chamfering		パイロット Pilot				製品自重 (g) Weight	単価 Price
		S		H		D	g	D1		t			
		基準寸法 Standard dimension	許容差 Tolerance	基準寸法 Standard dimension	許容差 Tolerance	(約) Approx	(最大) Max	基準寸法 Standard dimension	許容差 Tolerance	基準寸法 Standard dimension	許容差 Tolerance		
BW-4	M4 (11x5)	11	0 -0.43	5	0 -0.3	7	0.5	7	-0.1 -0.3	0.8	0 -0.2	2.8	¥10
BW-5	M5 (11x5)			5	0 -0.3	7		7				3	¥10
BW-6	M6 (13x6)	13	0 -0.43	6	0 -0.3	9	0.8	9	-0.1 -0.3	1.2	0 -0.2	5	¥10
BW-8	M8 (15x7.5)	15		7.5	0 -0.36	11		11				8	¥10
BW-10	M10 (17x9)	17	0 -0.52	9	0 -0.43	13	0.8	13	-0.1 -0.3	1.2	0 -0.2	11	¥16
BW-12	M12 (19x11)	19		11	0 -0.43	15		15				15.4	¥25

グリーンボルト

GREEN BOLTS



BG(BS)・BGK(BS)・BGS(SS)

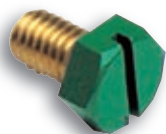

BG-610



BG-810



BGK-515



BGS-815

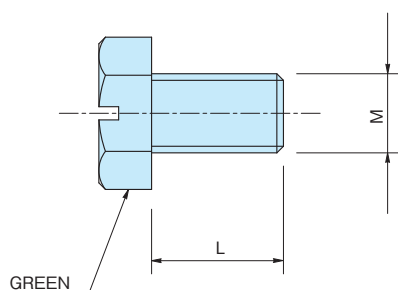
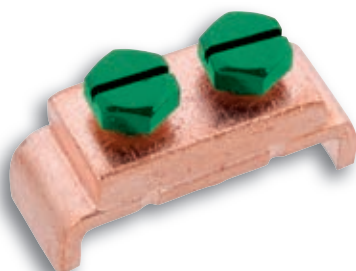

特 徴 ●六角ボルトに、頭部「グリーン色」の焼付塗装を施してあります。
Feature ●Hex head bolt is baked in green color.

材 質 ●BG/黄銅
 ●BGK/黄銅
 ●BGS/鉄

用 途 ●アース端子取り付けネジ等
備 考 ●BG(頭マイナス)、BGK・BGS(頭プラス)

Material ●BG/Brass
 ●BGK/Brass
 ●BGS/SS











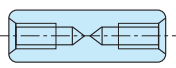

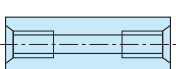

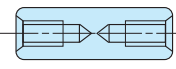

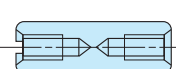

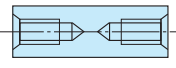

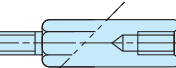

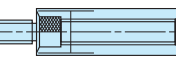
Specific Use ●Earth terminals, etc.

Remarks ●Phillips-head bolts are also available.

品 番 Product No.	M	L	製品自重(g) Weight	単 価 Price
BG-508	5	8	2.4	¥32
BG-510	5	10	2.6	¥32
BG-515	5	15	3.4	¥35
BG-608	6	8	4	¥42
BG-610	6	10	4.3	¥42
BG-612	6	12	4.6	¥45
BG-615	6	15	5.2	¥50
BG-810	8	10	9.4	¥75
BG-812	8	12	10	¥80
BG-815	8	15	10.8	¥82
BG-1012	10	12	19.4	¥150
BG-1016	10	16	21.4	¥150

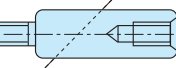
品 番 Product No.	M	L	自 重(g) Weight	単 価 Price
BGK-508	5	8	2.4	¥25
BGK-510	5	10	2.6	¥25
BGK-515	5	15	3.4	¥30
BGK-608	6	8	4	¥35
BGK-610	6	10	4.4	¥37
BGK-612	6	12	4.6	¥40
BGK-615	6	15	5.2	¥45
BGK-810	8	10	9.4	¥75
BGK-812	8	12	10	¥80
BGK-815	8	15	10.8	¥85
BGK-1012	10	12	19.4	¥200
BGK-1016	10	16	21.4	¥200

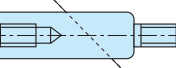
品 番 Product No.	M	L	自 重(g) Weight	単 価 Price
BGS-508	5	8	2.3	¥14
BGS-510	5	10	2.4	¥14
BGS-512	5	12	2.6	¥15
BGS-515	5	15	2.9	¥15
BGS-608	6	8	3.4	¥20
BGS-610	6	10	3.7	¥20
BGS-612	6	12	4.0	¥22
BGS-615	6	15	4.5	¥23
BGS-810	8	10	7.9	¥40
BGS-812	8	12	8.6	¥40
BGS-815	8	15	9.1	¥42
BGS-1016	10	16	18.3	¥70
BGS-1020	10	20	20.2	¥75

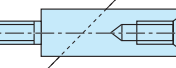
		六角ボス ASF-300E~800E (SS) P.31-32 ASU-300~800 (SUS) P.33-35 ASB-300E~600E (BS) P.36-38
		六角ボス (ジュラコン) AS-300~500 (POM) P.39-40
		丸ボス ARB-300E~400E (BS) P.41 ARU-300 (SUS) P.43 ARU-300S (SUS) P.44
		丸ボス (スリ割付) ARB-300SE~400SE (BS) P.42
		丸ボス (ジュラコン) AR-300~500 (POM) P.45-46
		六角サポーター BSF-300E~800E (SS) P.47-48 BSU-300~800 (SUS) P.49-51 BSB-300E~500E (BS) P.52-53
		六角サポーター (ジュラコン) BS-300E (POM) P.54
		六角サポーター (ジュラコン) BS-400E (POM) P.55
		六角サポーター (両オネジ) ESB-300E~400E (BS) P.56 ESU-300 (SUS) P.56
		丸サポーター BRB-300E~400E (BS) P.57 BRU-300 (SUS) P.59 BRU-300S (SUS) P.59
		丸サポーター (スリ割付) BRB-300SE~400SE (BS) P.58
		丸サポーター (オールジュラコン) BR-300A~400A (POM) P.60

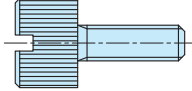
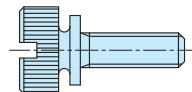
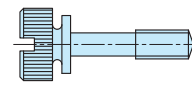
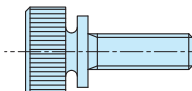
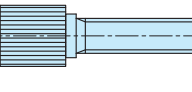
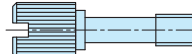
	ローレットビス NB-300A~500A (BS) P.61-62
	NB-300B~500B (BS) P.63
	NB-300E~500E (BS) P.64
	NB-300C~500C (BS) P.65
	NB-300D~500D (BS) P.66
	NB-300F~500F (BS) P.67-68

六角ボス

HEXAGONAL TAPPED BOSSES

ASF-300E~800E (SS)

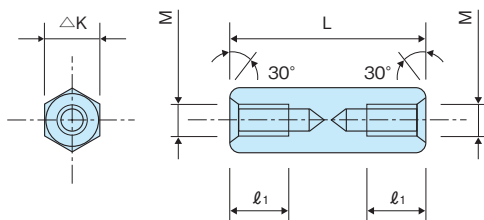

Lの公差/L=60迄±0.1、L=61以上~100迄±0.2、L=110以上±0.3

材質 ●快削鋼 (SUM)

表面処理 ●三価クロメート

Material ●Free-cutting steel (SUM)

Finish ●Trivalent chromate plating

※市販品につき、ケース単位(入数)でのご注文をお願い致します。

品番 Product No.	M	L	ℓ ₁	ΔK	入数 Lot	単価 Price
ASF-303E	3	3	全ネジ	5.5	50	¥28
ASF-303.5E	3	3.5	全ネジ	5.5	50	¥27
ASF-304E	3	4	全ネジ	5.5	50	¥27
ASF-304.5E	3	4.5	全ネジ	5.5	50	¥27
ASF-305E	3	5	全ネジ	5.5	50	¥20
ASF-305.5E	3	5.5	全ネジ	5.5	50	¥27
ASF-306E	3	6	全ネジ	5.5	50	¥27
ASF-306.5E	3	6.5	全ネジ	5.5	50	¥27
ASF-307E	3	7	全ネジ	5.5	50	¥27
ASF-307.5E	3	7.5	全ネジ	5.5	50	¥28
ASF-308E	3	8	全ネジ	5.5	50	¥28
ASF-308.5E	3	8.5	全ネジ	5.5	50	¥28
ASF-309E	3	9	全ネジ	5.5	50	¥28
ASF-309.5E	3	9.5	全ネジ	5.5	50	¥30
ASF-310E	3	10	全ネジ	5.5	50	¥22
ASF-311E	3	11	全ネジ	5.5	50	¥30
ASF-312E	3	12	全ネジ	5.5	50	¥29
ASF-312.5E	3	12.5	全ネジ	5.5	50	¥29
ASF-313E	3	13	全ネジ	5.5	50	¥29
ASF-314E	3	14	全ネジ	5.5	50	¥31
ASF-315E	3	15	全ネジ	5.5	50	¥24
ASF-316E	3	16	6	5.5	50	¥32
ASF-316.5E	3	16.5	6	5.5	50	¥32
ASF-317E	3	17	6	5.5	50	¥32
ASF-317.5E	3	17.5	6	5.5	50	¥33
ASF-318E	3	18	6	5.5	50	¥33
ASF-319E	3	19	6	5.5	50	¥34
ASF-320E	3	20	6	5.5	50	¥29
ASF-321E	3	21	6	5.5	50	¥36
ASF-322E	3	22	6	5.5	50	¥36
ASF-323E	3	23	6	5.5	50	¥39
ASF-324E	3	24	6	5.5	50	¥39
ASF-325E	3	25	6	5.5	50	¥34
ASF-326E	3	26	6	5.5	50	¥39
ASF-327E	3	27	6	5.5	50	¥42
ASF-328E	3	28	6	5.5	50	¥44
ASF-329E	3	29	6	5.5	50	¥49
ASF-330E	3	30	6	5.5	50	¥43
ASF-335E	3	35	6	5.5	50	¥44
ASF-340E	3	40	6	5.5	50	¥48
ASF-345E	3	45	6	5.5	50	¥53
ASF-350E	3	50	6	5.5	50	¥56
ASF-355E	3	55	6	5.5	50	¥61
ASF-360E	3	60	6	5.5	50	¥69
ASF-365E	3	65	6	5.5	50	¥79

品番 Product No.	M	L	ℓ ₁	ΔK	入数 Lot	単価 Price
ASF-370E	3	70	6	5.5	50	¥84
ASF-375E	3	75	6	5.5	50	¥89
ASF-380E	3	80	6	5.5	50	¥94
ASF-385E	3	85	6	5.5	50	¥97
ASF-390E	3	90	6	5.5	50	¥97
ASF-395E	3	95	6	5.5	50	¥97
ASF-3100E	3	100	6	5.5	50	¥99
ASF-405E	4	5	全ネジ	7	50	¥29
ASF-406E	4	6	全ネジ	7	50	¥29
ASF-407E	4	7	全ネジ	7	50	¥29
ASF-408E	4	8	全ネジ	7	50	¥29
ASF-409E	4	9	全ネジ	7	50	¥34
ASF-410E	4	10	全ネジ	7	50	¥34
ASF-411E	4	11	全ネジ	7	50	¥34
ASF-412E	4	12	全ネジ	7	50	¥34
ASF-413E	4	13	全ネジ	7	50	¥34
ASF-414E	4	14	全ネジ	7	50	¥38
ASF-415E	4	15	全ネジ	7	50	¥38
ASF-416E	4	16	7.5	7	50	¥38
ASF-417E	4	17	7.5	7	50	¥38
ASF-418E	4	18	7.5	7	50	¥38
ASF-419E	4	19	7.5	7	50	¥38
ASF-420E	4	20	7.5	7	50	¥43
ASF-421E	4	21	7.5	7	50	¥43
ASF-422E	4	22	7.5	7	50	¥43
ASF-423E	4	23	7.5	7	50	¥43
ASF-424E	4	24	7.5	7	50	¥43
ASF-425E	4	25	7.5	7	50	¥43
ASF-426E	4	26	7.5	7	50	¥49
ASF-427E	4	27	7.5	7	50	¥49
ASF-428E	4	28	7.5	7	50	¥49
ASF-429E	4	29	7.5	7	50	¥49
ASF-430E	4	30	7.5	7	50	¥49

品番 Product No.	M	L	ℓ ₁	△K	入数 Lot	単価 Price
ASF-431E	4	31	7.5	7	50	¥51
ASF-432E	4	32	7.5	7	50	¥54
ASF-433E	4	33	7.5	7	50	¥54
ASF-434E	4	34	7.5	7	50	¥54
ASF-435E	4	35	7.5	7	50	¥54
ASF-436E	4	36	7.5	7	50	¥59
ASF-437E	4	37	7.5	7	50	¥59
ASF-438E	4	38	7.5	7	50	¥59
ASF-439E	4	39	7.5	7	50	¥59
ASF-440E	4	40	7.5	7	50	¥59
ASF-441E	4	41	7.5	7	50	¥62
ASF-442E	4	42	7.5	7	50	¥64
ASF-443E	4	43	7.5	7	50	¥64
ASF-444E	4	44	7.5	7	50	¥64
ASF-445E	4	45	7.5	7	50	¥64
ASF-446E	4	46	7.5	7	50	¥69
ASF-447E	4	47	7.5	7	50	¥69
ASF-448E	4	48	7.5	7	50	¥69
ASF-449E	4	49	7.5	7	50	¥69
ASF-450E	4	50	7.5	7	50	¥69
ASF-451E	4	51	7.5	7	50	¥72
ASF-452E	4	52	7.5	7	50	¥74
ASF-453E	4	53	7.5	7	50	¥74
ASF-454E	4	54	7.5	7	50	¥74
ASF-455E	4	55	7.5	7	50	¥74
ASF-456E	4	56	7.5	7	50	¥84
ASF-457E	4	57	7.5	7	50	¥84
ASF-458E	4	58	7.5	7	50	¥84
ASF-459E	4	59	7.5	7	50	¥86
ASF-460E	4	60	7.5	7	50	¥89
ASF-462E	4	62	7.5	7	50	¥89
ASF-464E	4	64	7.5	7	50	¥89
ASF-465E	4	65	7.5	7	50	¥94
ASF-466E	4	66	7.5	7	50	¥94
ASF-468E	4	68	7.5	7	50	¥94
ASF-470E	4	70	7.5	7	50	¥94
ASF-472E	4	72	7.5	7	50	¥94
ASF-474E	4	74	7.5	7	50	¥94
ASF-475E	4	75	7.5	7	50	¥99
ASF-476E	4	76	7.5	7	50	¥99
ASF-478E	4	78	7.5	7	50	¥99
ASF-480E	4	80	7.5	7	50	¥99
ASF-485E	4	85	7.5	7	50	¥104
ASF-490E	4	90	7.5	7	50	¥109
ASF-495E	4	95	7.5	7	50	¥111
ASF-4100E	4	100	7.5	7	50	¥113
ASF-4110E	4	110	7.5	7	50	¥174
ASF-4120E	4	120	7.5	7	50	¥179
ASF-4130E	4	130	7.5	7	50	¥184
ASF-4140E	4	140	7.5	7	50	¥189
ASF-4150E	4	150	7.5	7	50	¥194
ASF-508E	5	8	全ネジ	8	10	¥59
ASF-510E	5	10	全ネジ	8	10	¥64
ASF-512E	5	12	全ネジ	8	10	¥69
ASF-515E	5	15	全ネジ	8	10	¥69
ASF-518E	5	18	全ネジ	8	10	¥74
ASF-520E	5	20	全ネジ	8	10	¥74
ASF-525E	5	25	10	8	10	¥79
ASF-530E	5	30	10	8	10	¥89
ASF-535E	5	35	10	8	10	¥94

品番 Product No.	M	L	ℓ ₁	△K	入数 Lot	単価 Price
ASF-540E	5	40	10	8	10	¥104
ASF-545E	5	45	10	8	10	¥114
ASF-550E	5	50	10	8	10	¥119
ASF-555E	5	55	10	8	10	¥124
ASF-560E	5	60	10	8	10	¥129
ASF-565E	5	65	10	8	10	¥132
ASF-570E	5	70	10	8	10	¥134
ASF-575E	5	75	10	8	10	¥139
ASF-580E	5	80	10	8	10	¥144
ASF-585E	5	85	10	8	10	¥149
ASF-590E	5	90	10	8	10	¥154
ASF-595E	5	95	10	8	10	¥159
ASF-5100E	5	100	10	8	10	¥164
ASF-5110E	5	110	10	8	10	¥174
ASF-5120E	5	120	10	8	10	¥187
ASF-5125E	5	125	10	8	10	¥189
ASF-5130E	5	130	10	8	10	¥189
ASF-5140E	5	140	10	8	10	¥194
ASF-5150E	5	150	10	8	10	¥199
ASF-610E	6	10	全ネジ	10	10	¥79
ASF-615E	6	15	全ネジ	10	10	¥84
ASF-620E	6	20	全ネジ	10	10	¥89
ASF-625E	6	25	10	10	10	¥92
ASF-630E	6	30	14	10	10	¥101
ASF-635E	6	35	14	10	10	¥106
ASF-640E	6	40	14	10	10	¥114
ASF-645E	6	45	14	10	10	¥124
ASF-650E	6	50	14	10	10	¥129
ASF-655E	6	55	14	10	10	¥134
ASF-660E	6	60	14	10	10	¥144
ASF-665E	6	65	14	10	10	¥147
ASF-670E	6	70	14	10	10	¥149
ASF-675E	6	75	14	10	10	¥154
ASF-680E	6	80	14	10	10	¥166
ASF-685E	6	85	14	10	10	¥169
ASF-690E	6	90	14	10	10	¥171
ASF-695E	6	95	14	10	10	¥174
ASF-6100E	6	100	14	10	10	¥176
ASF-6110E	6	110	14	10	10	¥179
ASF-6120E	6	120	14	10	10	¥184
ASF-6125E	6	125	14	10	10	¥196
ASF-6130E	6	130	14	10	10	¥204
ASF-6140E	6	140	14	10	10	¥214
ASF-6150E	6	150	14	10	10	¥216
ASF-850E	8	50	17	13	10	¥194
ASF-860E	8	60	17	13	10	¥214
ASF-870E	8	70	17	13	10	¥234
ASF-880E	8	80	17	13	10	¥254
ASF-890E	8	90	17	13	10	¥274
ASF-8100E	8	100	17	13	10	¥294
ASF-8125E	8	125	17	13	10	¥324
ASF-8150E	8	150	17	13	10	¥364

六角ボス(ステンレス)

HEXAGONAL TAPPED BOSSES (STAINLESS)

ASU-300~800 (SUS)

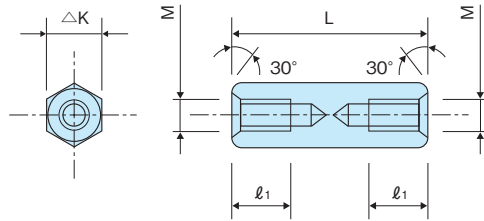

Lの公差/L=60迄±0.1、L=61以上~100迄±0.2、L=110以上±0.3

材質 ●快削ステンレス鋼 (SUS303)

表面処理 ●脱脂

Material ●Free-cutting stainless steel (SUS303)

Finish ●Degreasing

※市販品につき、ケース単位(入数)でのご注文をお願い致します。

品番 Product No.	M	L	ℓ ₁	ΔK	入数 Lot	単価 Price
ASU-303	3	3	全ネジ	5.5	50	¥53
ASU-303.5	3	3.5	全ネジ	5.5	50	¥53
ASU-304	3	4	全ネジ	5.5	50	¥51
ASU-304.5	3	4.5	全ネジ	5.5	50	¥51
ASU-305	3	5	全ネジ	5.5	50	¥51
ASU-305.5	3	5.5	全ネジ	5.5	50	¥51
ASU-306	3	6	全ネジ	5.5	50	¥51
ASU-306.5	3	6.5	全ネジ	5.5	50	¥51
ASU-307	3	7	全ネジ	5.5	50	¥51
ASU-307.5	3	7.5	全ネジ	5.5	50	¥51
ASU-308	3	8	全ネジ	5.5	50	¥51
ASU-308.5	3	8.5	全ネジ	5.5	50	¥56
ASU-309	3	9	全ネジ	5.5	50	¥56
ASU-309.5	3	9.5	全ネジ	5.5	50	¥56
ASU-310	3	10	全ネジ	5.5	50	¥54
ASU-310.5	3	10.5	全ネジ	5.5	50	¥54
ASU-311	3	11	全ネジ	5.5	50	¥56
ASU-311.5	3	11.5	全ネジ	5.5	50	¥56
ASU-312	3	12	全ネジ	5.5	50	¥56
ASU-312.5	3	12.5	6	5.5	50	¥65
ASU-313	3	13	6	5.5	50	¥65
ASU-313.5	3	13.5	6	5.5	50	¥65
ASU-314	3	14	6	5.5	50	¥65
ASU-314.5	3	14.5	6	5.5	50	¥65
ASU-315	3	15	6	5.5	50	¥65
ASU-315.5	3	15.5	6	5.5	50	¥65
ASU-316	3	16	6	5.5	50	¥71
ASU-316.5	3	16.5	6	5.5	50	¥71
ASU-317	3	17	6	5.5	50	¥71
ASU-317.5	3	17.5	6	5.5	50	¥73
ASU-318	3	18	6	5.5	50	¥71
ASU-318.5	3	18.5	6	5.5	50	¥71
ASU-319	3	19	6	5.5	50	¥71
ASU-319.5	3	19.5	6	5.5	50	¥71
ASU-320	3	20	6	5.5	50	¥73
ASU-321	3	21	6	5.5	50	¥74
ASU-322	3	22	6	5.5	50	¥74
ASU-323	3	23	6	5.5	50	¥76
ASU-324	3	24	6	5.5	50	¥76
ASU-325	3	25	6	5.5	50	¥78
ASU-326	3	26	6	5.5	50	¥81
ASU-327	3	27	6	5.5	50	¥81

品番 Product No.	M	L	ℓ ₁	ΔK	入数 Lot	単価 Price
ASU-328	3	28	6	5.5	50	¥84
ASU-329	3	29	6	5.5	50	¥84
ASU-330	3	30	6	5.5	50	¥87
ASU-331	3	31	6	5.5	50	¥97
ASU-332	3	32	6	5.5	50	¥97
ASU-333	3	33	6	5.5	50	¥97
ASU-334	3	34	6	5.5	50	¥97
ASU-335	3	35	6	5.5	50	¥95
ASU-336	3	36	6	5.5	50	¥102
ASU-337	3	37	6	5.5	50	¥102
ASU-338	3	38	6	5.5	50	¥102
ASU-339	3	39	6	5.5	50	¥102
ASU-340	3	40	6	5.5	50	¥100
ASU-341	3	41	6	5.5	50	¥106
ASU-342	3	42	6	5.5	50	¥106
ASU-343	3	43	6	5.5	50	¥106
ASU-344	3	44	6	5.5	50	¥106
ASU-345	3	45	6	5.5	50	¥106
ASU-346	3	46	6	5.5	50	¥108
ASU-347	3	47	6	5.5	50	¥108
ASU-348	3	48	6	5.5	50	¥108
ASU-349	3	49	6	5.5	50	¥108
ASU-350	3	50	6	5.5	50	¥106
ASU-351	3	51	6	5.5	50	¥111
ASU-352	3	52	6	5.5	50	¥111
ASU-353	3	53	6	5.5	50	¥111
ASU-354	3	54	6	5.5	50	¥111
ASU-355	3	55	6	5.5	50	¥111
ASU-356	3	56	6	5.5	50	¥135
ASU-357	3	57	6	5.5	50	¥135
ASU-358	3	58	6	5.5	50	¥135
ASU-359	3	59	6	5.5	50	¥135
ASU-360	3	60	6	5.5	50	¥133
ASU-365	3	65	6	5.5	50	¥150
ASU-370	3	70	6	5.5	50	¥161
ASU-375	3	75	6	5.5	50	¥166
ASU-380	3	80	6	5.5	50	¥177
ASU-385	3	85	6	5.5	50	¥183
ASU-390	3	90	6	5.5	50	¥194
ASU-395	3	95	6	5.5	50	¥199
ASU-3100	3	100	6	5.5	50	¥210

品番 Product No.	M	L	φ ₁	△K	入数 Lot	単価 Price
ASU-405	4	5	全ネジ	7	50	¥62
ASU-405.5	4	5.5	全ネジ	7	50	¥62
ASU-406	4	6	全ネジ	7	50	¥62
ASU-406.5	4	6.5	全ネジ	7	50	¥62
ASU-407	4	7	全ネジ	7	50	¥62
ASU-407.5	4	7.5	全ネジ	7	50	¥62
ASU-408	4	8	全ネジ	7	50	¥67
ASU-408.5	4	8.5	全ネジ	7	50	¥67
ASU-409	4	9	全ネジ	7	50	¥67
ASU-409.5	4	9.5	全ネジ	7	50	¥67
ASU-410	4	10	全ネジ	7	50	¥62
ASU-410.5	4	10.5	全ネジ	7	50	¥67
ASU-411	4	11	全ネジ	7	50	¥67
ASU-411.5	4	11.5	全ネジ	7	50	¥67
ASU-412	4	12	全ネジ	7	50	¥67
ASU-412.5	4	12.5	全ネジ	7	50	¥67
ASU-413	4	13	全ネジ	7	50	¥73
ASU-413.5	4	13.5	全ネジ	7	50	¥73
ASU-414	4	14	全ネジ	7	50	¥73
ASU-414.5	4	14.5	全ネジ	7	50	¥73
ASU-415	4	15	全ネジ	7	50	¥73
ASU-415.5	4	15.5	全ネジ	7	50	¥73
ASU-416	4	16	全ネジ	7	50	¥84
ASU-416.5	4	16.5	8	7	50	¥84
ASU-417	4	17	8	7	50	¥84
ASU-417.5	4	17.5	8	7	50	¥84
ASU-418	4	18	8	7	50	¥84
ASU-418.5	4	18.5	8	7	50	¥84
ASU-419	4	19	8	7	50	¥84
ASU-419.5	4	19.5	8	7	50	¥84
ASU-420	4	20	8	7	50	¥84
ASU-421	4	21	8	7	50	¥89
ASU-422	4	22	8	7	50	¥95
ASU-423	4	23	8	7	50	¥95
ASU-424	4	24	8	7	50	¥95
ASU-425	4	25	8	7	50	¥100
ASU-426	4	26	8	7	50	¥106
ASU-427	4	27	8	7	50	¥106
ASU-428	4	28	8	7	50	¥106
ASU-429	4	29	8	7	50	¥106
ASU-430	4	30	8	7	50	¥117
ASU-431	4	31	8	7	50	¥117
ASU-432	4	32	8	7	50	¥117
ASU-433	4	33	8	7	50	¥117
ASU-434	4	34	8	7	50	¥117
ASU-435	4	35	8	7	50	¥122
ASU-436	4	36	8	7	50	¥133
ASU-437	4	37	8	7	50	¥133
ASU-438	4	38	8	7	50	¥133
ASU-439	4	39	8	7	50	¥133
ASU-440	4	40	8	7	50	¥133
ASU-441	4	41	8	7	50	¥133
ASU-442	4	42	8	7	50	¥133
ASU-443	4	43	8	7	50	¥133
ASU-444	4	44	8	7	50	¥133
ASU-445	4	45	8	7	50	¥133
ASU-446	4	46	8	7	50	¥144
ASU-447	4	47	8	7	50	¥144

品番 Product No.	M	L	φ ₁	△K	入数 Lot	単価 Price
ASU-448	4	48	8	7	50	¥144
ASU-449	4	49	8	7	50	¥144
ASU-450	4	50	8	7	50	¥144
ASU-451	4	51	8	7	50	¥155
ASU-452	4	52	8	7	50	¥155
ASU-453	4	53	8	7	50	¥155
ASU-454	4	54	8	7	50	¥155
ASU-455	4	55	8	7	50	¥155
ASU-456	4	56	8	7	50	¥172
ASU-457	4	57	8	7	50	¥172
ASU-458	4	58	8	7	50	¥172
ASU-459	4	59	8	7	50	¥172
ASU-460	4	60	8	7	50	¥172
ASU-462	4	62	8	7	50	¥194
ASU-464	4	64	8	7	50	¥194
ASU-465	4	65	8	7	50	¥183
ASU-466	4	66	8	7	50	¥194
ASU-468	4	68	8	7	50	¥194
ASU-470	4	70	8	7	50	¥188
ASU-472	4	72	8	7	50	¥205
ASU-474	4	74	8	7	50	¥205
ASU-475	4	75	8	7	50	¥199
ASU-476	4	76	8	7	50	¥205
ASU-478	4	78	8	7	50	¥205
ASU-480	4	80	8	7	50	¥205
ASU-485	4	85	8	7	50	¥221
ASU-490	4	90	8	7	50	¥232
ASU-495	4	95	8	7	50	¥243
ASU-4100	4	100	8	7	50	¥265
ASU-4110	4	110	8	7	50	¥276
ASU-4120	4	120	8	7	50	¥298
ASU-4130	4	130	8	7	50	¥320
ASU-4140	4	140	8	7	50	¥342
ASU-4150	4	150	8	7	50	¥386

六角ボス(ステンレス)

HEXAGONAL TAPPED BOSSSES (STAINLESS)

ASU-300~800 (SUS)

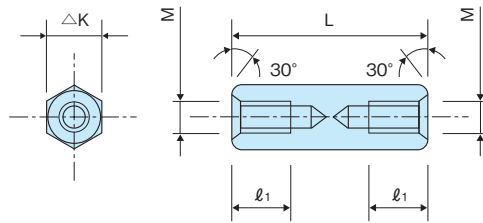

Lの公差/L=60迄±0.1、L=61以上~100迄±0.2、L=110以上±0.3

材質 ●快削ステンレス鋼 (SUS303)
表面処理 ●脱脂

Material ●Free-cutting stainless steel (SUS303)
Finish ●Degreasing

※市販品につき、ケース単位(入数)でのご注文をお願い致します。

品番 Product No.	M	L	ℓ ₁	ΔK	入数 Lot	単価 Price
ASU-508	5	8	全ネジ	8	10	¥100
ASU-510	5	10	全ネジ	8	10	¥100
ASU-512	5	12	全ネジ	8	10	¥111
ASU-515	5	15	全ネジ	8	10	¥111
ASU-518	5	18	全ネジ	8	10	¥111
ASU-520	5	20	全ネジ	8	10	¥111
ASU-525	5	25	10	8	10	¥144
ASU-530	5	30	10	8	10	¥144
ASU-535	5	35	10	8	10	¥155
ASU-540	5	40	10	8	10	¥166
ASU-545	5	45	10	8	10	¥177
ASU-550	5	50	10	8	10	¥188
ASU-555	5	55	10	8	10	¥199
ASU-560	5	60	10	8	10	¥199
ASU-565	5	65	10	8	10	¥243
ASU-570	5	70	10	8	10	¥254
ASU-575	5	75	10	8	10	¥265
ASU-580	5	80	10	8	10	¥276
ASU-585	5	85	10	8	10	¥287
ASU-590	5	90	10	8	10	¥309
ASU-595	5	95	10	8	10	¥353
ASU-5100	5	100	10	8	10	¥386
ASU-5110	5	110	10	8	10	¥441
ASU-5120	5	120	10	8	10	¥496
ASU-5125	5	125	10	8	10	¥496
ASU-5130	5	130	10	8	10	¥551
ASU-5140	5	140	10	8	10	¥584
ASU-5150	5	150	10	8	10	¥606
ASU-610	6	10	全ネジ	10	10	¥122
ASU-615	6	15	全ネジ	10	10	¥133
ASU-620	6	20	全ネジ	10	10	¥139
ASU-625	6	25	10	10	10	¥155
ASU-630	6	30	14	10	10	¥172
ASU-635	6	35	14	10	10	¥199
ASU-640	6	40	14	10	10	¥216
ASU-645	6	45	14	10	10	¥243
ASU-650	6	50	14	10	10	¥265
ASU-655	6	55	14	10	10	¥287
ASU-660	6	60	14	10	10	¥331
ASU-665	6	65	14	10	10	¥353
ASU-670	6	70	14	10	10	¥364
ASU-675	6	75	14	10	10	¥386

品番 Product No.	M	L	ℓ ₁	ΔK	入数 Lot	単価 Price
ASU-680	6	80	14	10	10	¥397
ASU-685	6	85	14	10	10	¥419
ASU-690	6	90	14	10	10	¥430
ASU-695	6	95	14	10	10	¥452
ASU-6100	6	100	14	10	10	¥474
ASU-6110	6	110	14	10	10	¥496
ASU-6120	6	120	14	10	10	¥518
ASU-6125	6	125	14	10	10	¥529
ASU-6130	6	130	14	10	10	¥551
ASU-6140	6	140	14	10	10	¥584
ASU-6150	6	150	14	10	10	¥606
ASU-850	8	50	17	13	10	¥719
ASU-860	8	60	17	13	10	¥761
ASU-870	8	70	17	13	10	¥804
ASU-880	8	80	17	13	10	¥846
ASU-890	8	90	17	13	10	¥889
ASU-8100	8	100	17	13	10	¥931
ASU-8125	8	125	17	13	10	¥974
ASU-8150	8	150	17	13	10	¥1,016

六角ボス(黄銅)

HEXAGONAL TAPPED BOSSES (BRASS)

ASB-300E~600E (BS)

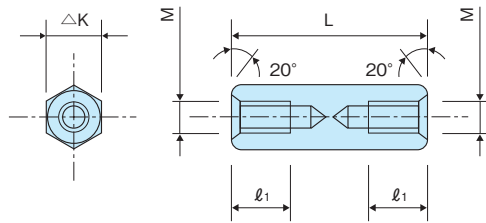

Lの公差/L=60迄±0.1、L=61以上~100迄±0.2、L=110以上±0.3

材 質 ●快削黄銅 (C3604BD)
表面処理 ●ニッケルメッキ

Material ●Free-cutting brass (C3604BD)
Finish ●Nickel plating

※市販品につき、ケース単位(入数)でのご注文をお願い致します。

品番 Product No.	M	L	ℓ ₁	ΔK	入数 Lot	単価 Price
ASB-303E	3	3	全ネジ	5.5	50	¥15
ASB-303.5E	3	3.5	全ネジ	5.5	50	¥15
ASB-304E	3	4	全ネジ	5.5	50	¥15
ASB-304.5E	3	4.5	全ネジ	5.5	50	¥15
ASB-305E	3	5	全ネジ	5.5	50	¥13
ASB-305.5E	3	5.5	全ネジ	5.5	50	¥15
ASB-306E	3	6	全ネジ	5.5	50	¥15
ASB-306.5E	3	6.5	全ネジ	5.5	50	¥17
ASB-307E	3	7	全ネジ	5.5	50	¥13
ASB-307.5E	3	7.5	全ネジ	5.5	50	¥17
ASB-308E	3	8	全ネジ	5.5	50	¥12
ASB-308.5E	3	8.5	全ネジ	5.5	50	¥17
ASB-309E	3	9	全ネジ	5.5	50	¥16
ASB-309.5E	3	9.5	全ネジ	5.5	50	¥17
ASB-310E	3	10	全ネジ	5.5	50	¥14
ASB-310.5E	3	10.5	全ネジ	5.5	50	¥17
ASB-311E	3	11	全ネジ	5.5	50	¥18
ASB-311.5E	3	11.5	全ネジ	5.5	50	¥18
ASB-312E	3	12	全ネジ	5.5	50	¥13
ASB-312.5E	3	12.5	全ネジ	5.5	50	¥18
ASB-313E	3	13	全ネジ	5.5	50	¥17
ASB-313.5E	3	13.5	全ネジ	5.5	50	¥18
ASB-314E	3	14	全ネジ	5.5	50	¥19
ASB-314.5E	3	14.5	全ネジ	5.5	50	¥19
ASB-315E	3	15	全ネジ	5.5	50	¥16
ASB-315.5E	3	15.5	全ネジ	5.5	50	¥19
ASB-316E	3	16	全ネジ	5.5	50	¥22
ASB-316.5E	3	16.5	全ネジ	5.5	50	¥22
ASB-317E	3	17	全ネジ	5.5	50	¥22
ASB-317.5E	3	17.5	全ネジ	5.5	50	¥22
ASB-318E	3	18	全ネジ	5.5	50	¥22
ASB-318.5E	3	18.5	全ネジ	5.5	50	¥22
ASB-319E	3	19	全ネジ	5.5	50	¥24
ASB-319.5E	3	19.5	全ネジ	5.5	50	¥24
ASB-320E	3	20	全ネジ	5.5	50	¥18
ASB-321E	3	21	6	5.5	50	¥26
ASB-322E	3	22	6	5.5	50	¥26
ASB-323E	3	23	6	5.5	50	¥26
ASB-324E	3	24	6	5.5	50	¥26
ASB-325E	3	25	6	5.5	50	¥25
ASB-326E	3	26	6	5.5	50	¥30
ASB-327E	3	27	6	5.5	50	¥30

品番 Product No.	M	L	ℓ ₁	ΔK	入数 Lot	単価 Price
ASB-328E	3	28	6	5.5	50	¥32
ASB-329E	3	29	6	5.5	50	¥32
ASB-330E	3	30	6	5.5	50	¥30
ASB-331E	3	31	6	5.5	50	¥33
ASB-332E	3	32	6	5.5	50	¥33
ASB-333E	3	33	6	5.5	50	¥35
ASB-334E	3	34	6	5.5	50	¥35
ASB-335E	3	35	6	5.5	50	¥32
ASB-336E	3	36	6	5.5	50	¥36
ASB-337E	3	37	6	5.5	50	¥36
ASB-338E	3	38	6	5.5	50	¥38
ASB-339E	3	39	6	5.5	50	¥38
ASB-340E	3	40	6	5.5	50	¥34
ASB-341E	3	41	6	5.5	50	¥40
ASB-342E	3	42	6	5.5	50	¥41
ASB-343E	3	43	6	5.5	50	¥43
ASB-344E	3	44	6	5.5	50	¥43
ASB-345E	3	45	6	5.5	50	¥39
ASB-346E	3	46	6	5.5	50	¥44
ASB-347E	3	47	6	5.5	50	¥44
ASB-348E	3	48	6	5.5	50	¥44
ASB-349E	3	49	6	5.5	50	¥44
ASB-350E	3	50	6	5.5	50	¥41
ASB-351E	3	51	6	5.5	50	¥46
ASB-352E	3	52	6	5.5	50	¥46
ASB-353E	3	53	6	5.5	50	¥48
ASB-354E	3	54	6	5.5	50	¥48
ASB-355E	3	55	6	5.5	50	¥46
ASB-356E	3	56	6	5.5	50	¥50
ASB-357E	3	57	6	5.5	50	¥50
ASB-358E	3	58	6	5.5	50	¥50
ASB-359E	3	59	6	5.5	50	¥50
ASB-360E	3	60	6	5.5	50	¥46
ASB-365E	3	65	6	5.5	50	¥58
ASB-370E	3	70	6	5.5	50	¥69
ASB-375E	3	75	6	5.5	50	¥74
ASB-380E	3	80	6	5.5	50	¥81
ASB-385E	3	85	6	5.5	50	¥84
ASB-390E	3	90	6	5.5	50	¥86
ASB-395E	3	95	6	5.5	50	¥91
ASB-3100E	3	100	6	5.5	50	¥95

六角ボス(黄銅)

HEXAGONAL TAPPED BOSSES (BRASS)

ASB-300E~600E (BS)

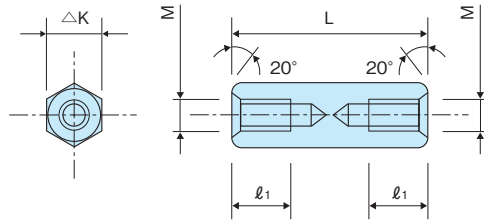

Lの公差/L=60迄±0.1、L=61以上~100迄±0.2、L=110以上±0.3

材質 ●快削黄銅 (C3604BD)

表面処理 ●ニッケルメッキ

Material ●Free-cutting brass (C3604BD)

Finish ●Nickel plating

※市販品につき、ケース単位(入数)でのご注文をお願い致します。

品番 Product No.	M	L	ℓ ₁	ΔK	入数 Lot	単価 Price
ASB-405E	4	5	全ネジ	7	50	¥22
ASB-405.5E	4	5.5	全ネジ	7	50	¥22
ASB-406E	4	6	全ネジ	7	50	¥22
ASB-406.5E	4	6.5	全ネジ	7	50	¥22
ASB-407E	4	7	全ネジ	7	50	¥23
ASB-407.5E	4	7.5	全ネジ	7	50	¥23
ASB-408E	4	8	全ネジ	7	50	¥23
ASB-408.5E	4	8.5	全ネジ	7	50	¥23
ASB-409E	4	9	全ネジ	7	50	¥23
ASB-409.5E	4	9.5	全ネジ	7	50	¥23
ASB-410E	4	10	全ネジ	7	50	¥21
ASB-410.5E	4	10.5	全ネジ	7	50	¥23
ASB-411E	4	11	全ネジ	7	50	¥24
ASB-411.5E	4	11.5	全ネジ	7	50	¥24
ASB-412E	4	12	全ネジ	7	50	¥25
ASB-412.5E	4	12.5	全ネジ	7	50	¥25
ASB-413E	4	13	全ネジ	7	50	¥26
ASB-413.5E	4	13.5	全ネジ	7	50	¥26
ASB-414E	4	14	全ネジ	7	50	¥26
ASB-414.5E	4	14.5	全ネジ	7	50	¥26
ASB-415E	4	15	全ネジ	7	50	¥23
ASB-415.5E	4	15.5	全ネジ	7	50	¥26
ASB-416E	4	16	全ネジ	7	50	¥28
ASB-416.5E	4	16.5	全ネジ	7	50	¥28
ASB-417E	4	17	全ネジ	7	50	¥30
ASB-417.5E	4	17.5	全ネジ	7	50	¥30
ASB-418E	4	18	全ネジ	7	50	¥29
ASB-418.5E	4	18.5	全ネジ	7	50	¥30
ASB-419E	4	19	全ネジ	7	50	¥32
ASB-419.5E	4	19.5	全ネジ	7	50	¥32
ASB-420E	4	20	全ネジ	7	50	¥29
ASB-421E	4	21	8	7	50	¥35
ASB-422E	4	22	8	7	50	¥35
ASB-423E	4	23	8	7	50	¥35
ASB-424E	4	24	8	7	50	¥35
ASB-425E	4	25	8	7	50	¥33
ASB-426E	4	26	8	7	50	¥39

品番 Product No.	M	L	ℓ ₁	ΔK	入数 Lot	単価 Price
ASB-427E	4	27	8	7	50	¥42
ASB-428E	4	28	8	7	50	¥42
ASB-429E	4	29	8	7	50	¥43
ASB-430E	4	30	8	7	50	¥37
ASB-431E	4	31	8	7	50	¥43
ASB-432E	4	32	8	7	50	¥43
ASB-433E	4	33	8	7	50	¥43
ASB-434E	4	34	8	7	50	¥43
ASB-435E	4	35	8	7	50	¥40
ASB-436E	4	36	8	7	50	¥44
ASB-437E	4	37	8	7	50	¥44
ASB-438E	4	38	8	7	50	¥44
ASB-439E	4	39	8	7	50	¥44
ASB-440E	4	40	8	7	50	¥43
ASB-441E	4	41	8	7	50	¥49
ASB-442E	4	42	8	7	50	¥49
ASB-443E	4	43	8	7	50	¥49
ASB-444E	4	44	8	7	50	¥49
ASB-445E	4	45	8	7	50	¥45
ASB-446E	4	46	8	7	50	¥52
ASB-447E	4	47	8	7	50	¥52
ASB-448E	4	48	8	7	50	¥52
ASB-449E	4	49	8	7	50	¥52
ASB-450E	4	50	8	7	50	¥50

品番 Product No.	M	L	φ ₁	△K	入数 Lot	単価 Price
ASB-451E	4	51	8	7	50	¥56
ASB-452E	4	52	8	7	50	¥56
ASB-453E	4	53	8	7	50	¥56
ASB-454E	4	54	8	7	50	¥56
ASB-455E	4	55	8	7	50	¥55
ASB-456E	4	56	8	7	50	¥61
ASB-457E	4	57	8	7	50	¥61
ASB-458E	4	58	8	7	50	¥61
ASB-459E	4	59	8	7	50	¥61
ASB-460E	4	60	8	7	50	¥57
ASB-462E	4	62	8	7	50	¥66
ASB-464E	4	64	8	7	50	¥66
ASB-465E	4	65	8	7	50	¥71
ASB-466E	4	66	8	7	50	¥74
ASB-468E	4	68	8	7	50	¥74
ASB-470E	4	70	8	7	50	¥83
ASB-472E	4	72	8	7	50	¥86
ASB-474E	4	74	8	7	50	¥86
ASB-475E	4	75	8	7	50	¥85
ASB-476E	4	76	8	7	50	¥91
ASB-478E	4	78	8	7	50	¥91
ASB-480E	4	80	8	7	50	¥87
ASB-485E	4	85	8	7	50	¥90
ASB-490E	4	90	8	7	50	¥92
ASB-495E	4	95	8	7	50	¥97
ASB-4100E	4	100	8	7	50	¥101
ASB-4110E	4	110	8	7	50	¥149
ASB-4120E	4	120	8	7	50	¥159
ASB-4130E	4	130	8	7	50	¥179
ASB-4140E	4	140	8	7	50	¥189
ASB-4150E	4	150	8	7	50	¥229
ASB-508E	5	8	全ネジ	8	10	¥39
ASB-510E	5	10	全ネジ	8	10	¥41
ASB-512E	5	12	全ネジ	8	10	¥42
ASB-515E	5	15	全ネジ	8	10	¥43
ASB-518E	5	18	全ネジ	8	10	¥45
ASB-520E	5	20	全ネジ	8	10	¥47
ASB-525E	5	25	10	8	10	¥51
ASB-530E	5	30	10	8	10	¥55
ASB-535E	5	35	10	8	10	¥58
ASB-540E	5	40	10	8	10	¥63
ASB-545E	5	45	10	8	10	¥73
ASB-550E	5	50	10	8	10	¥78
ASB-555E	5	55	10	8	10	¥81
ASB-560E	5	60	10	8	10	¥83
ASB-565E	5	65	10	8	10	¥91
ASB-570E	5	70	10	8	10	¥93
ASB-575E	5	75	10	8	10	¥101
ASB-580E	5	80	10	8	10	¥103
ASB-585E	5	85	10	8	10	¥116
ASB-590E	5	90	10	8	10	¥116
ASB-595E	5	95	10	8	10	¥121
ASB-5100E	5	100	10	8	10	¥121

品番 Product No.	M	L	φ ₁	△K	入数 Lot	単価 Price
ASB-5110E	5	110	10	8	10	¥166
ASB-5120E	5	120	10	8	10	¥176
ASB-5125E	5	125	10	8	10	¥176
ASB-5130E	5	130	10	8	10	¥186
ASB-5140E	5	140	10	8	10	¥196
ASB-5150E	5	150	10	8	10	¥211
ASB-610E	6	10	全ネジ	10	10	¥72
ASB-615E	6	15	全ネジ	10	10	¥77
ASB-620E	6	20	全ネジ	10	10	¥82
ASB-625E	6	25	10	10	10	¥87
ASB-630E	6	30	14	10	10	¥97
ASB-635E	6	35	14	10	10	¥102
ASB-640E	6	40	14	10	10	¥116
ASB-645E	6	45	14	10	10	¥126
ASB-650E	6	50	14	10	10	¥134
ASB-655E	6	55	14	10	10	¥141
ASB-660E	6	60	14	10	10	¥146
ASB-665E	6	65	14	10	10	¥149
ASB-670E	6	70	14	10	10	¥151
ASB-675E	6	75	14	10	10	¥156
ASB-680E	6	80	14	10	10	¥161
ASB-685E	6	85	14	10	10	¥166
ASB-690E	6	90	14	10	10	¥169
ASB-695E	6	95	14	10	10	¥172
ASB-6100E	6	100	14	10	10	¥176
ASB-6110E	6	110	14	10	10	¥186
ASB-6120E	6	120	14	10	10	¥191
ASB-6125E	6	125	14	10	10	¥196
ASB-6130E	6	130	14	10	10	¥206
ASB-6140E	6	140	14	10	10	¥211
ASB-6150E	6	150	14	10	10	¥216

六角ボス(ジュラコン)

HEXAGONAL TAPPED BOLTS (POLYACETAL)

AS-300~500 (POM)

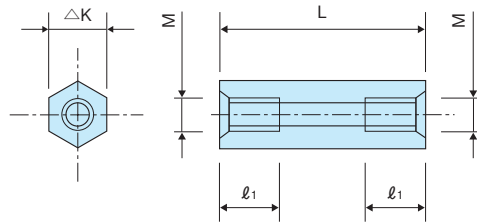

Lの公差/L=15迄±0.1、L=16以上~100迄±0.2、L=110以上±0.3

材質 ●ジュラコン(POM)
色 ●乳白色
熱変形温度 ●1.82MPa...110°
UL規格 ●UL94-HB(材料)

Material ●Polyacetal (POM)
Color ●Milky-white
Heat deflection temperature ●1.82MPa...110°
UL standards ●UL94-HB (Material)

※市販品につき、ケース単位(入数)でのご注文をお願い致します。

品番 Product No.	M	L	ℓ ₁	△K	入数 Lot	単価 Price
AS-303	3	3	全ネジ	5.5	50	¥13
AS-303.5	3	3.5	全ネジ	5.5	50	¥14
AS-304	3	4	全ネジ	5.5	50	¥11
AS-304.5	3	4.5	全ネジ	5.5	50	¥12
AS-305	3	5	全ネジ	5.5	50	¥11
AS-305.5	3	5.5	全ネジ	5.5	50	¥12
AS-306	3	6	全ネジ	5.5	50	¥11
AS-306.5	3	6.5	全ネジ	5.5	50	¥12
AS-307	3	7	全ネジ	5.5	50	¥11
AS-307.5	3	7.5	全ネジ	5.5	50	¥14
AS-308	3	8	全ネジ	5.5	50	¥9
AS-308.5	3	8.5	全ネジ	5.5	50	¥13
AS-309	3	9	全ネジ	5.5	50	¥12
AS-309.5	3	9.5	全ネジ	5.5	50	¥14
AS-310	3	10	全ネジ	5.5	50	¥9
AS-311	3	11	全ネジ	5.5	50	¥15
AS-312	3	12	全ネジ	5.5	50	¥10
AS-312.5	3	12.5	全ネジ	5.5	50	¥16
AS-313	3	13	全ネジ	5.5	50	¥13
AS-314	3	14	全ネジ	5.5	50	¥15
AS-315	3	15	全ネジ	5.5	50	¥10
AS-316	3	16	全ネジ	5.5	50	¥18
AS-316.5	3	16.5	全ネジ	5.5	50	¥18
AS-317	3	17	全ネジ	5.5	50	¥18
AS-317.5	3	17.5	全ネジ	5.5	50	¥18
AS-318	3	18	全ネジ	5.5	50	¥16
AS-319	3	19	全ネジ	5.5	50	¥18
AS-320	3	20	全ネジ	5.5	50	¥13
AS-321	3	21	全ネジ	5.5	50	¥21
AS-322	3	22	全ネジ	5.5	50	¥21
AS-323	3	23	全ネジ	5.5	50	¥21
AS-324	3	24	全ネジ	5.5	50	¥21
AS-325	3	25	全ネジ	5.5	50	¥19
AS-326	3	26	全ネジ	5.5	50	¥23
AS-327	3	27	全ネジ	5.5	50	¥23
AS-328	3	28	全ネジ	5.5	50	¥23
AS-329	3	29	全ネジ	5.5	50	¥23
AS-330	3	30	全ネジ	5.5	50	¥21
AS-331	3	31	全ネジ	5.5	50	¥23
AS-332	3	32	全ネジ	5.5	50	¥23
AS-333	3	33	全ネジ	5.5	50	¥24
AS-334	3	34	全ネジ	5.5	50	¥24
AS-335	3	35	全ネジ	5.5	50	¥23
AS-336	3	36	全ネジ	5.5	50	¥25
AS-337	3	37	全ネジ	5.5	50	¥26

品番 Product No.	M	L	ℓ ₁	△K	入数 Lot	単価 Price
AS-338	3	38	全ネジ	5.5	50	¥26
AS-339	3	39	全ネジ	5.5	50	¥27
AS-340	3	40	全ネジ	5.5	50	¥26
AS-345	3	45	全ネジ	5.5	50	¥29
AS-350	3	50	全ネジ	5.5	50	¥31
AS-355	3	55	全ネジ	5.5	50	¥36
AS-360	3	60	全ネジ	5.5	50	¥36
AS-405	4	5	全ネジ	7	50	¥14
AS-406	4	6	全ネジ	7	50	¥14
AS-407	4	7	全ネジ	7	50	¥13
AS-408	4	8	全ネジ	7	50	¥13
AS-409	4	9	全ネジ	7	50	¥14
AS-410	4	10	全ネジ	7	50	¥14
AS-411	4	11	全ネジ	7	50	¥15
AS-412	4	12	全ネジ	7	50	¥15
AS-413	4	13	全ネジ	7	50	¥15
AS-414	4	14	全ネジ	7	50	¥16
AS-415	4	15	全ネジ	7	50	¥16
AS-416	4	16	全ネジ	7	50	¥18
AS-417	4	17	全ネジ	7	50	¥19
AS-418	4	18	全ネジ	7	50	¥18
AS-419	4	19	全ネジ	7	50	¥19
AS-420	4	20	全ネジ	7	50	¥19

品番 Product No.	M	L	\varnothing_1	ΔK	入数 Lot	単価 Price
AS-421	4	21	全ネジ	7	50	¥21
AS-422	4	22	全ネジ	7	50	¥23
AS-423	4	23	全ネジ	7	50	¥24
AS-424	4	24	全ネジ	7	50	¥24
AS-425	4	25	全ネジ	7	50	¥23
AS-426	4	26	全ネジ	7	50	¥25
AS-427	4	27	全ネジ	7	50	¥26
AS-428	4	28	全ネジ	7	50	¥26
AS-429	4	29	全ネジ	7	50	¥26
AS-430	4	30	全ネジ	7	50	¥25
AS-431	4	31	全ネジ	7	50	¥29
AS-432	4	32	全ネジ	7	50	¥29
AS-433	4	33	全ネジ	7	50	¥29
AS-434	4	34	全ネジ	7	50	¥29
AS-435	4	35	全ネジ	7	50	¥27
AS-436	4	36	全ネジ	7	50	¥33
AS-437	4	37	全ネジ	7	50	¥33
AS-438	4	38	全ネジ	7	50	¥33
AS-439	4	39	全ネジ	7	50	¥33
AS-440	4	40	全ネジ	7	50	¥29
AS-441	4	41	全ネジ	7	50	¥36
AS-442	4	42	全ネジ	7	50	¥36
AS-443	4	43	全ネジ	7	50	¥36
AS-444	4	44	全ネジ	7	50	¥36
AS-445	4	45	全ネジ	7	50	¥34
AS-446	4	46	全ネジ	7	50	¥40
AS-447	4	47	全ネジ	7	50	¥40
AS-448	4	48	全ネジ	7	50	¥40
AS-449	4	49	全ネジ	7	50	¥40
AS-450	4	50	全ネジ	7	50	¥37
AS-451	4	51	全ネジ	7	50	¥43
AS-452	4	52	全ネジ	7	50	¥43
AS-453	4	53	全ネジ	7	50	¥43
AS-454	4	54	全ネジ	7	50	¥43
AS-455	4	55	全ネジ	7	50	¥42
AS-456	4	56	全ネジ	7	50	¥47
AS-457	4	57	全ネジ	7	50	¥47
AS-458	4	58	全ネジ	7	50	¥47
AS-459	4	59	全ネジ	7	50	¥47
AS-460	4	60	全ネジ	7	50	¥45
AS-462	4	62	全ネジ	7	50	¥49
AS-464	4	64	全ネジ	7	50	¥49
AS-465	4	65	全ネジ	7	50	¥51
AS-466	4	66	8	7	50	¥55
AS-468	4	68	8	7	50	¥55
AS-470	4	70	8	7	50	¥56
AS-472	4	72	8	7	50	¥59
AS-474	4	74	8	7	50	¥59
AS-475	4	75	8	7	50	¥58
AS-476	4	76	8	7	50	¥67
AS-478	4	78	8	7	50	¥67
AS-480	4	80	8	7	50	¥66
AS-485	4	85	8	7	50	¥69
AS-490	4	90	8	7	50	¥71
AS-495	4	95	8	7	50	¥76
AS-4100	4	100	8	7	50	¥81
AS-4110	4	110	8	7	50	¥91
AS-4120	4	120	8	7	50	¥97
AS-4130	4	130	8	7	50	¥101
AS-4140	4	140	8	7	50	¥111
AS-4150	4	150	8	7	50	¥121

品番 Product No.	M	L	\varnothing_1	ΔK	入数 Lot	単価 Price
AS-508	5	8	全ネジ	8	10	¥19
AS-510	5	10	全ネジ	8	10	¥19
AS-512	5	12	全ネジ	8	10	¥20
AS-515	5	15	全ネジ	8	10	¥21
AS-518	5	18	全ネジ	8	10	¥23
AS-520	5	20	全ネジ	8	10	¥26
AS-525	5	25	全ネジ	8	10	¥31
AS-530	5	30	全ネジ	8	10	¥34
AS-535	5	35	全ネジ	8	10	¥36
AS-540	5	40	全ネジ	8	10	¥41
AS-545	5	45	全ネジ	8	10	¥46
AS-550	5	50	全ネジ	8	10	¥51
AS-555	5	55	全ネジ	8	10	¥56
AS-560	5	60	全ネジ	8	10	¥56
AS-565	5	65	10	8	10	¥61
AS-570	5	70	10	8	10	¥66
AS-575	5	75	10	8	10	¥71
AS-580	5	80	10	8	10	¥76
AS-585	5	85	10	8	10	¥81
AS-590	5	90	10	8	10	¥86
AS-595	5	95	10	8	10	¥91
AS-5100	5	100	10	8	10	¥101
AS-5110	5	110	10	8	10	¥101
AS-5120	5	120	10	8	10	¥106
AS-5125	5	125	10	8	10	¥106
AS-5130	5	130	10	8	10	¥111
AS-5140	5	140	10	8	10	¥116
AS-5150	5	150	10	8	10	¥123

丸ボス

ROUND TAPPED BOSSES

ARB-300E~400E (BS)

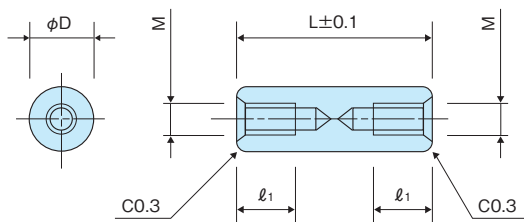

材質 ●快削黄銅 (C3604BD)

表面処理 ●ニッケルメッキ

Material ●Free-cutting brass (C3604BD)

Finish ●Nickel plating

※市販品につき、ケース単位(入数)でのご注文をお願い致します。

品番 Product No.	M	L	ℓ_1	ϕD	入数 Lot	単価 Price
ARB-304E	3	4	全ネジ	6	50	¥17
ARB-304.5E	3	4.5	全ネジ	6	50	¥17
ARB-305E	3	5	全ネジ	6	50	¥17
ARB-305.5E	3	5.5	全ネジ	6	50	¥17
ARB-306E	3	6	全ネジ	6	50	¥17
ARB-306.5E	3	6.5	全ネジ	6	50	¥17
ARB-307E	3	7	全ネジ	6	50	¥17
ARB-307.5E	3	7.5	全ネジ	6	50	¥17
ARB-308E	3	8	全ネジ	6	50	¥17
ARB-308.5E	3	8.5	全ネジ	6	50	¥18
ARB-309E	3	9	全ネジ	6	50	¥18
ARB-309.5E	3	9.5	全ネジ	6	50	¥18
ARB-310E	3	10	全ネジ	6	50	¥18
ARB-311E	3	11	全ネジ	6	50	¥19
ARB-312E	3	12	全ネジ	6	50	¥20
ARB-312.5E	3	12.5	全ネジ	6	50	¥21
ARB-313E	3	13	全ネジ	6	50	¥21
ARB-314E	3	14	全ネジ	6	50	¥21
ARB-315E	3	15	全ネジ	6	50	¥21
ARB-316E	3	16	6	6	50	¥22
ARB-316.5E	3	16.5	6	6	50	¥23
ARB-317E	3	17	6	6	50	¥23
ARB-317.5E	3	17.5	6	6	50	¥24
ARB-318E	3	18	6	6	50	¥25
ARB-319E	3	19	6	6	50	¥26
ARB-320E	3	20	6	6	50	¥27
ARB-321E	3	21	6	6	50	¥28
ARB-322E	3	22	6	6	50	¥29
ARB-323E	3	23	6	6	50	¥30
ARB-324E	3	24	6	6	50	¥31
ARB-325E	3	25	6	6	50	¥33
ARB-326E	3	26	6	6	50	¥34
ARB-327E	3	27	6	6	50	¥35
ARB-328E	3	28	6	6	50	¥36
ARB-329E	3	29	6	6	50	¥36
ARB-330E	3	30	6	6	50	¥36
ARB-335E	3	35	6	6	50	¥38
ARB-340E	3	40	6	6	50	¥41
ARB-345E	3	45	6	6	50	¥48
ARB-350E	3	50	6	6	50	¥53
ARB-355E	3	55	6	6	50	¥58
ARB-360E	3	60	6	6	50	¥63

品番 Product No.	M	L	ℓ_1	ϕD	入数 Lot	単価 Price
ARB-405E	4	5	全ネジ	8	50	¥30
ARB-406E	4	6	全ネジ	8	50	¥30
ARB-407E	4	7	全ネジ	8	50	¥30
ARB-408E	4	8	全ネジ	8	50	¥30
ARB-409E	4	9	全ネジ	8	50	¥31
ARB-410E	4	10	全ネジ	8	50	¥32
ARB-411E	4	11	全ネジ	8	50	¥33
ARB-412E	4	12	全ネジ	8	50	¥34
ARB-413E	4	13	全ネジ	8	50	¥34
ARB-414E	4	14	全ネジ	8	50	¥35
ARB-415E	4	15	全ネジ	8	50	¥35
ARB-416E	4	16	全ネジ	8	50	¥38
ARB-417E	4	17	8	8	50	¥40
ARB-418E	4	18	8	8	50	¥41
ARB-419E	4	19	8	8	50	¥42
ARB-420E	4	20	8	8	50	¥43
ARB-421E	4	21	8	8	50	¥46
ARB-422E	4	22	8	8	50	¥50
ARB-423E	4	23	8	8	50	¥50
ARB-424E	4	24	8	8	50	¥50
ARB-425E	4	25	8	8	50	¥51
ARB-426E	4	26	8	8	50	¥53
ARB-427E	4	27	8	8	50	¥55
ARB-428E	4	28	8	8	50	¥56
ARB-429E	4	29	8	8	50	¥56
ARB-430E	4	30	8	8	50	¥56
ARB-435E	4	35	8	8	50	¥58
ARB-440E	4	40	8	8	50	¥61
ARB-445E	4	45	8	8	50	¥67
ARB-450E	4	50	8	8	50	¥70
ARB-455E	4	55	8	8	50	¥77
ARB-460E	4	60	8	8	50	¥79

丸ボス(スリ割付)

ROUND TAPPED BOSES (SLOTTED)

ARB-300SE~400SE (BS)

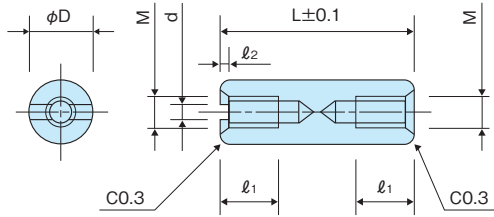

材 質 ●快削黄銅 (C3604BD)

表面処理 ●ニッケルメッキ

Material ●Free-cutting brass (C3604BD)

Finish ●Nickel plating

※市販品につき、ケース単位(入数)でのご注文をお願い致します。

品番 Product No.	M	L	ℓ ₁	φD	d	ℓ ₂	入数 Lot	単価 Price
ARB-304SE	3	4	全ネジ	6	1.0	1.0	50	¥30
ARB-304.5SE	3	4.5	全ネジ	6	1.0	1.0	50	¥30
ARB-305SE	3	5	全ネジ	6	1.0	1.0	50	¥30
ARB-305.5SE	3	5.5	全ネジ	6	1.0	1.0	50	¥30
ARB-306SE	3	6	全ネジ	6	1.0	1.0	50	¥30
ARB-306.5SE	3	6.5	全ネジ	6	1.0	1.0	50	¥30
ARB-307SE	3	7	全ネジ	6	1.0	1.0	50	¥30
ARB-307.5SE	3	7.5	全ネジ	6	1.0	1.0	50	¥30
ARB-308SE	3	8	全ネジ	6	1.0	1.0	50	¥30
ARB-308.5SE	3	8.5	全ネジ	6	1.0	1.0	50	¥31
ARB-309SE	3	9	全ネジ	6	1.0	1.0	50	¥31
ARB-309.5SE	3	9.5	全ネジ	6	1.0	1.0	50	¥32
ARB-310SE	3	10	全ネジ	6	1.0	1.0	50	¥32
ARB-311SE	3	11	全ネジ	6	1.0	1.0	50	¥32
ARB-312SE	3	12	全ネジ	6	1.0	1.0	50	¥32
ARB-312.5SE	3	12.5	全ネジ	6	1.0	1.0	50	¥33
ARB-313SE	3	13	全ネジ	6	1.0	1.0	50	¥33
ARB-314SE	3	14	全ネジ	6	1.0	1.0	50	¥33
ARB-315SE	3	15	全ネジ	6	1.0	1.0	50	¥35
ARB-316SE	3	16	6	6	1.0	1.0	50	¥35
ARB-316.5SE	3	16.5	6	6	1.0	1.0	50	¥36
ARB-317SE	3	17	6	6	1.0	1.0	50	¥37
ARB-317.5SE	3	17.5	6	6	1.0	1.0	50	¥38
ARB-318SE	3	18	6	6	1.0	1.0	50	¥39
ARB-319SE	3	19	6	6	1.0	1.0	50	¥39
ARB-320SE	3	20	6	6	1.0	1.0	50	¥39
ARB-321SE	3	21	6	6	1.0	1.0	50	¥40
ARB-322SE	3	22	6	6	1.0	1.0	50	¥41
ARB-323SE	3	23	6	6	1.0	1.0	50	¥42
ARB-324SE	3	24	6	6	1.0	1.0	50	¥43
ARB-325SE	3	25	6	6	1.0	1.0	50	¥44
ARB-326SE	3	26	6	6	1.0	1.0	50	¥45
ARB-327SE	3	27	6	6	1.0	1.0	50	¥46
ARB-328SE	3	28	6	6	1.0	1.0	50	¥47
ARB-329SE	3	29	6	6	1.0	1.0	50	¥47
ARB-330SE	3	30	6	6	1.0	1.0	50	¥47
ARB-335SE	3	35	6	6	1.0	1.0	50	¥48
ARB-340SE	3	40	6	6	1.0	1.0	50	¥51
ARB-345SE	3	45	6	6	1.0	1.0	50	¥56
ARB-350SE	3	50	6	6	1.0	1.0	50	¥62
ARB-355SE	3	55	6	6	1.0	1.0	50	¥66
ARB-360SE	3	60	6	6	1.0	1.0	50	¥70

品番 Product No.	M	L	ℓ ₁	φD	d	ℓ ₂	入数 Lot	単価 Price
ARB-405SE	4	5	全ネジ	8	1.5	1.5	50	¥32
ARB-406SE	4	6	全ネジ	8	1.5	1.5	50	¥32
ARB-407SE	4	7	全ネジ	8	1.5	1.5	50	¥32
ARB-408SE	4	8	全ネジ	8	1.5	1.5	50	¥32
ARB-409SE	4	9	全ネジ	8	1.5	1.5	50	¥33
ARB-410SE	4	10	全ネジ	8	1.5	1.5	50	¥34
ARB-411SE	4	11	全ネジ	8	1.5	1.5	50	¥35
ARB-412SE	4	12	全ネジ	8	1.5	1.5	50	¥36
ARB-413SE	4	13	全ネジ	8	1.5	1.5	50	¥36
ARB-414SE	4	14	全ネジ	8	1.5	1.5	50	¥37
ARB-415SE	4	15	全ネジ	8	1.5	1.5	50	¥37
ARB-416SE	4	16	全ネジ	8	1.5	1.5	50	¥40
ARB-417SE	4	17	8	8	1.5	1.5	50	¥42
ARB-418SE	4	18	8	8	1.5	1.5	50	¥43
ARB-419SE	4	19	8	8	1.5	1.5	50	¥44
ARB-420SE	4	20	8	8	1.5	1.5	50	¥45
ARB-421SE	4	21	8	8	1.5	1.5	50	¥48
ARB-422SE	4	22	8	8	1.5	1.5	50	¥52
ARB-423SE	4	23	8	8	1.5	1.5	50	¥52
ARB-424SE	4	24	8	8	1.5	1.5	50	¥52
ARB-425SE	4	25	8	8	1.5	1.5	50	¥53
ARB-426SE	4	26	8	8	1.5	1.5	50	¥55
ARB-427SE	4	27	8	8	1.5	1.5	50	¥57
ARB-428SE	4	28	8	8	1.5	1.5	50	¥58
ARB-429SE	4	29	8	8	1.5	1.5	50	¥58
ARB-430SE	4	30	8	8	1.5	1.5	50	¥58
ARB-435SE	4	35	8	8	1.5	1.5	50	¥60
ARB-440SE	4	40	8	8	1.5	1.5	50	¥63
ARB-445SE	4	45	8	8	1.5	1.5	50	¥69
ARB-450SE	4	50	8	8	1.5	1.5	50	¥72
ARB-455SE	4	55	8	8	1.5	1.5	50	¥79
ARB-460SE	4	60	8	8	1.5	1.5	50	¥81

丸ボス(ステンレス)

ROUND TAPPED BOSSES (STAINLESS)



ARU-300 (SUS)

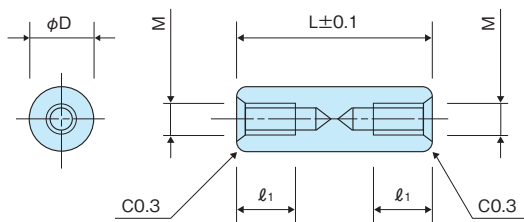

材質 ●快削ステンレス鋼 (SUS303)

表面処理 ●脱脂

Material ●Free-cutting stainless steel (SUS303)

Finish ●Degreasing

※市販品につき、ケース単位(入数)でのご注文をお願い致します。

品番 Product No.	M	L	ℓ ₁	φD	入数 Lot	単価 Price
ARU-304	3	4	全ネジ	6	50	¥40
ARU-304.5	3	4.5	全ネジ	6	50	¥40
ARU-305	3	5	全ネジ	6	50	¥40
ARU-305.5	3	5.5	全ネジ	6	50	¥40
ARU-306	3	6	全ネジ	6	50	¥45
ARU-306.5	3	6.5	全ネジ	6	50	¥45
ARU-307	3	7	全ネジ	6	50	¥48
ARU-307.5	3	7.5	全ネジ	6	50	¥48
ARU-308	3	8	全ネジ	6	50	¥48
ARU-308.5	3	8.5	全ネジ	6	50	¥48
ARU-309	3	9	全ネジ	6	50	¥51
ARU-309.5	3	9.5	全ネジ	6	50	¥51
ARU-310	3	10	全ネジ	6	50	¥52
ARU-311	3	11	全ネジ	6	50	¥54
ARU-312	3	12	全ネジ	6	50	¥54
ARU-312.5	3	12.5	全ネジ	6	50	¥54
ARU-313	3	13	全ネジ	6	50	¥65
ARU-314	3	14	6	6	50	¥65
ARU-315	3	15	6	6	50	¥65
ARU-316	3	16	6	6	50	¥69
ARU-316.5	3	16.5	6	6	50	¥69

品番 Product No.	M	L	ℓ ₁	φD	入数 Lot	単価 Price
ARU-317	3	17	6	6	50	¥69
ARU-317.5	3	17.5	6	6	50	¥69
ARU-318	3	18	6	6	50	¥69
ARU-319	3	19	6	6	50	¥71
ARU-320	3	20	6	6	50	¥71
ARU-321	3	21	6	6	50	¥72
ARU-322	3	22	6	6	50	¥73
ARU-323	3	23	6	6	50	¥74
ARU-324	3	24	6	6	50	¥75
ARU-325	3	25	6	6	50	¥76
ARU-326	3	26	6	6	50	¥78
ARU-327	3	27	6	6	50	¥80
ARU-328	3	28	6	6	50	¥82
ARU-329	3	29	6	6	50	¥82
ARU-330	3	30	6	6	50	¥84
ARU-335	3	35	6	6	50	¥89
ARU-340	3	40	6	6	50	¥95
ARU-345	3	45	6	6	50	¥98
ARU-350	3	50	6	6	50	¥100
ARU-355	3	55	6	6	50	¥106
ARU-360	3	60	6	6	50	¥122

丸ボス(ステンレス)(スリ割付)

ROUND TAPPED BOSES (STAINLESS) (SLOTTED)

ARU-300S (SUS)



材質 ● 快削ステンレス鋼 (SUS303)
 表面処理 ● 脱脂

Material ● Free-cutting stainless steel (SUS303)
 Finish ● Degreasing

※市販品につき、ケース単位(入数)でのご注文をお願い致します。

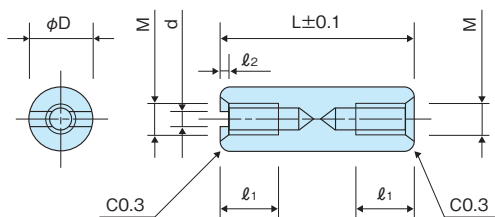

品番 Product No.	M	L	ℓ ₁	φD	d	ℓ ₂	入数 Lot	単価 Price
ARU-304S	3	4	全ネジ	6	1.0	1.0	50	¥56
ARU-304.5S	3	4.5	全ネジ	6	1.0	1.0	50	¥56
ARU-305S	3	5	全ネジ	6	1.0	1.0	50	¥56
ARU-305.5S	3	5.5	全ネジ	6	1.0	1.0	50	¥56
ARU-306S	3	6	全ネジ	6	1.0	1.0	50	¥62
ARU-306.5S	3	6.5	全ネジ	6	1.0	1.0	50	¥62
ARU-307S	3	7	全ネジ	6	1.0	1.0	50	¥65
ARU-307.5S	3	7.5	全ネジ	6	1.0	1.0	50	¥65
ARU-308S	3	8	全ネジ	6	1.0	1.0	50	¥65
ARU-308.5S	3	8.5	全ネジ	6	1.0	1.0	50	¥65
ARU-309S	3	9	全ネジ	6	1.0	1.0	50	¥67
ARU-309.5S	3	9.5	全ネジ	6	1.0	1.0	50	¥67
ARU-310S	3	10	全ネジ	6	1.0	1.0	50	¥69
ARU-311S	3	11	全ネジ	6	1.0	1.0	50	¥70
ARU-312S	3	12	全ネジ	6	1.0	1.0	50	¥70
ARU-312.5S	3	12.5	全ネジ	6	1.0	1.0	50	¥70
ARU-313S	3	13	全ネジ	6	1.0	1.0	50	¥81
ARU-314S	3	14	6	6	1.0	1.0	50	¥81
ARU-315S	3	15	6	6	1.0	1.0	50	¥81
ARU-316S	3	16	6	6	1.0	1.0	50	¥86
ARU-316.5S	3	16.5	6	6	1.0	1.0	50	¥86

品番 Product No.	M	L	ℓ ₁	φD	d	ℓ ₂	入数 Lot	単価 Price
ARU-317S	3	17	6	6	1.0	1.0	50	¥86
ARU-317.5S	3	17.5	6	6	1.0	1.0	50	¥86
ARU-318S	3	18	6	6	1.0	1.0	50	¥86
ARU-319S	3	19	6	6	1.0	1.0	50	¥86
ARU-320S	3	20	6	6	1.0	1.0	50	¥88
ARU-321S	3	21	6	6	1.0	1.0	50	¥88
ARU-322S	3	22	6	6	1.0	1.0	50	¥90
ARU-323S	3	23	6	6	1.0	1.0	50	¥90
ARU-324S	3	24	6	6	1.0	1.0	50	¥92
ARU-325S	3	25	6	6	1.0	1.0	50	¥92
ARU-326S	3	26	6	6	1.0	1.0	50	¥94
ARU-327S	3	27	6	6	1.0	1.0	50	¥96
ARU-328S	3	28	6	6	1.0	1.0	50	¥97
ARU-329S	3	29	6	6	1.0	1.0	50	¥98
ARU-330S	3	30	6	6	1.0	1.0	50	¥100
ARU-335S	3	35	6	6	1.0	1.0	50	¥106
ARU-340S	3	40	6	6	1.0	1.0	50	¥111
ARU-345S	3	45	6	6	1.0	1.0	50	¥114
ARU-350S	3	50	6	6	1.0	1.0	50	¥117
ARU-355S	3	55	6	6	1.0	1.0	50	¥122
ARU-360S	3	60	6	6	1.0	1.0	50	¥139

丸ボス(ジュラコン)

ROUND TAPPED BOSSES (POLYACETAL)

AR-300~500 (POM)

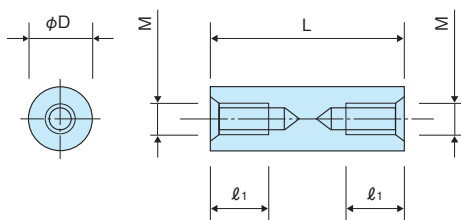

Lの公差/L=15迄±0.1、L=16以上~100迄±0.2、L=110以上±0.3

材質 ●ジュラコン(POM)

色 ●乳白色

熱変形温度 ●1.82MPa...110°

UL規格 ●UL94-HB(材料)

Material ●Polyacetal (POM)

Color ●Milky-white

Heat deflection temperature ●1.82MPa...110°

UL standards ●UL94-HB (Material)

※市販品につき、ケース単位(入数)でのご注文をお願い致します。

品番 Product No.	M	L	ℓ ₁	φD	入数 Lot	単価 Price
AR-303	3	3	全ネジ	6	50	¥17
AR-303.5	3	3.5	全ネジ	6	50	¥17
AR-304	3	4	全ネジ	6	50	¥15
AR-304.5	3	4.5	全ネジ	6	50	¥15
AR-305	3	5	全ネジ	6	50	¥15
AR-305.5	3	5.5	全ネジ	6	50	¥15
AR-306	3	6	全ネジ	6	50	¥15
AR-306.5	3	6.5	全ネジ	6	50	¥15
AR-307	3	7	全ネジ	6	50	¥15
AR-307.5	3	7.5	全ネジ	6	50	¥15
AR-308	3	8	全ネジ	6	50	¥16
AR-308.5	3	8.5	全ネジ	6	50	¥16
AR-309	3	9	全ネジ	6	50	¥16
AR-309.5	3	9.5	全ネジ	6	50	¥16
AR-310	3	10	全ネジ	6	50	¥16
AR-311	3	11	全ネジ	6	50	¥17
AR-312	3	12	全ネジ	6	50	¥17
AR-312.5	3	12.5	全ネジ	6	50	¥17
AR-313	3	13	全ネジ	6	50	¥17
AR-314	3	14	全ネジ	6	50	¥18
AR-315	3	15	全ネジ	6	50	¥18
AR-316	3	16	全ネジ	6	50	¥18
AR-316.5	3	16.5	全ネジ	6	50	¥19
AR-317	3	17	全ネジ	6	50	¥19
AR-317.5	3	17.5	全ネジ	6	50	¥19
AR-318	3	18	全ネジ	6	50	¥19
AR-319	3	19	全ネジ	6	50	¥22
AR-320	3	20	全ネジ	6	50	¥24
AR-321	3	21	全ネジ	6	50	¥25
AR-322	3	22	全ネジ	6	50	¥25
AR-323	3	23	全ネジ	6	50	¥26
AR-324	3	24	全ネジ	6	50	¥26
AR-325	3	25	全ネジ	6	50	¥26
AR-326	3	26	6	6	50	¥29
AR-327	3	27	6	6	50	¥29
AR-328	3	28	6	6	50	¥30
AR-329	3	29	6	6	50	¥31
AR-330	3	30	6	6	50	¥30
AR-331	3	31	6	6	50	¥33
AR-332	3	32	6	6	50	¥33
AR-333	3	33	6	6	50	¥34
AR-334	3	34	6	6	50	¥34
AR-335	3	35	6	6	50	¥32
AR-336	3	36	6	6	50	¥35

品番 Product No.	M	L	ℓ ₁	φD	入数 Lot	単価 Price
AR-337	3	37	6	6	50	¥35
AR-338	3	38	6	6	50	¥39
AR-339	3	39	6	6	50	¥39
AR-340	3	40	6	6	50	¥36
AR-345	3	45	6	6	50	¥39
AR-350	3	50	6	6	50	¥41
AR-355	3	55	6	6	50	¥44
AR-360	3	60	6	6	50	¥46
AR-326R	3	26	全ネジ	6	50	¥24
AR-327R	3	27	全ネジ	6	50	¥24
AR-328R	3	28	全ネジ	6	50	¥26
AR-329R	3	29	全ネジ	6	50	¥26
AR-330R	3	30	全ネジ	6	50	¥26
AR-331R	3	31	全ネジ	6	50	¥29
AR-332R	3	32	全ネジ	6	50	¥29
AR-333R	3	33	全ネジ	6	50	¥30
AR-334R	3	34	全ネジ	6	50	¥30
AR-335R	3	35	全ネジ	6	50	¥28
AR-336R	3	36	全ネジ	6	50	¥31
AR-337R	3	37	全ネジ	6	50	¥31
AR-338R	3	38	全ネジ	6	50	¥34
AR-339R	3	39	全ネジ	6	50	¥34
AR-340R	3	40	全ネジ	6	50	¥34
AR-345R	3	45	全ネジ	6	50	¥35
AR-350R	3	50	全ネジ	6	50	¥36
AR-355R	3	55	全ネジ	6	50	¥39
AR-360R	3	60	全ネジ	6	50	¥40
AR-405	4	5	全ネジ	8	50	¥18
AR-406	4	6	全ネジ	8	50	¥17
AR-407	4	7	全ネジ	8	50	¥17
AR-408	4	8	全ネジ	8	50	¥17
AR-409	4	9	全ネジ	8	50	¥17
AR-410	4	10	全ネジ	8	50	¥17
AR-411	4	11	全ネジ	8	50	¥18
AR-412	4	12	全ネジ	8	50	¥18
AR-413	4	13	全ネジ	8	50	¥18
AR-414	4	14	全ネジ	8	50	¥19
AR-415	4	15	全ネジ	8	50	¥19
AR-416	4	16	全ネジ	8	50	¥21
AR-417	4	17	全ネジ	8	50	¥22
AR-418	4	18	全ネジ	8	50	¥22
AR-419	4	19	全ネジ	8	50	¥24
AR-420	4	20	全ネジ	8	50	¥24

品番 Product No.	M	L	ℓ ₁	φD	入数 Lot	単価 Price
AR-421	4	21	全ネジ	8	50	¥25
AR-422	4	22	全ネジ	8	50	¥26
AR-423	4	23	全ネジ	8	50	¥26
AR-424	4	24	全ネジ	8	50	¥27
AR-425	4	25	全ネジ	8	50	¥27
AR-426	4	26	全ネジ	8	50	¥30
AR-427	4	27	全ネジ	8	50	¥30
AR-428	4	28	8	8	50	¥31
AR-429	4	29	8	8	50	¥31
AR-430	4	30	8	8	50	¥31
AR-431	4	31	8	8	50	¥36
AR-432	4	32	8	8	50	¥36
AR-433	4	33	8	8	50	¥36
AR-434	4	34	8	8	50	¥36
AR-435	4	35	8	8	50	¥33
AR-436	4	36	8	8	50	¥39
AR-437	4	37	8	8	50	¥39
AR-438	4	38	8	8	50	¥39
AR-439	4	39	8	8	50	¥39
AR-440	4	40	8	8	50	¥36
AR-441	4	41	8	8	50	¥41
AR-442	4	42	8	8	50	¥41
AR-443	4	43	8	8	50	¥41
AR-444	4	44	8	8	50	¥41
AR-445	4	45	8	8	50	¥40
AR-446	4	46	8	8	50	¥46
AR-447	4	47	8	8	50	¥46
AR-448	4	48	8	8	50	¥46
AR-449	4	49	8	8	50	¥46
AR-450	4	50	8	8	50	¥45
AR-451	4	51	8	8	50	¥51
AR-452	4	52	8	8	50	¥51
AR-453	4	53	8	8	50	¥51
AR-454	4	54	8	8	50	¥51
AR-455	4	55	8	8	50	¥49
AR-456	4	56	8	8	50	¥56
AR-457	4	57	8	8	50	¥56
AR-458	4	58	8	8	50	¥56
AR-459	4	59	8	8	50	¥56
AR-460	4	60	8	8	50	¥55
AR-462	4	62	8	8	50	¥61
AR-464	4	64	8	8	50	¥63
AR-465	4	65	8	8	50	¥65
AR-466	4	66	8	8	50	¥67
AR-468	4	68	8	8	50	¥69
AR-470	4	70	8	8	50	¥66
AR-472	4	72	8	8	50	¥71
AR-474	4	74	8	8	50	¥73
AR-475	4	75	8	8	50	¥75
AR-476	4	76	8	8	50	¥77
AR-478	4	78	8	8	50	¥79
AR-480	4	80	8	8	50	¥76
AR-485	4	85	8	8	50	¥81
AR-490	4	90	8	8	50	¥81
AR-495	4	95	8	8	50	¥86
AR-4100	4	100	8	8	50	¥86
AR-4110	4	110	8	8	50	¥91
AR-4120	4	120	8	8	50	¥97
AR-4130	4	130	8	8	50	¥101
AR-4140	4	140	8	8	50	¥111

品番 Product No.	M	L	ℓ ₁	φD	入数 Lot	単価 Price
AR-4150	4	150	8	8	50	¥121
AR-508	5	8	全ネジ	10	10	¥22
AR-510	5	10	全ネジ	10	10	¥22
AR-512	5	12	全ネジ	10	10	¥24
AR-515	5	15	全ネジ	10	10	¥26
AR-518	5	18	全ネジ	10	10	¥29
AR-520	5	20	全ネジ	10	10	¥32
AR-525	5	25	全ネジ	10	10	¥36
AR-530	5	30	10	10	10	¥40
AR-535	5	35	10	10	10	¥43
AR-540	5	40	10	10	10	¥46
AR-545	5	45	10	10	10	¥51
AR-550	5	50	10	10	10	¥56
AR-555	5	55	10	10	10	¥61
AR-560	5	60	10	10	10	¥66
AR-565	5	65	10	10	10	¥71
AR-570	5	70	10	10	10	¥76
AR-575	5	75	10	10	10	¥78
AR-580	5	80	10	10	10	¥81
AR-585	5	85	10	10	10	¥86
AR-590	5	90	10	10	10	¥91
AR-595	5	95	10	10	10	¥94
AR-5100	5	100	10	10	10	¥96
AR-5110	5	110	10	10	10	¥101
AR-5120	5	120	10	10	10	¥106
AR-5125	5	125	10	10	10	¥111
AR-5130	5	130	10	10	10	¥116
AR-5140	5	140	10	10	10	¥121
AR-5150	5	150	10	10	10	¥126

六角サポーター

HEXAGONAL SPACER

BSF-300E~800E (ss)

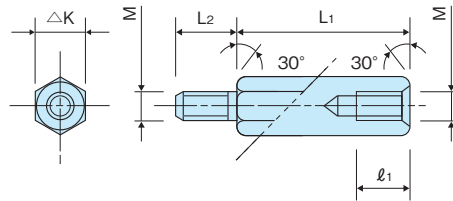

Lの公差/L=60迄±0.1、L=61以上~100迄±0.2、L=110以上±0.3

材質 ●快削鋼 (SUM)
表面処理 ●三価クロメート

Material ●Free-cutting steel (SUM)
Finish ●Trivalent chromate plating

※市販品につき、ケース単位(入数)でのご注文をお願い致します。

品番 Product No.	M	L ₁	L ₂	l ₁	ΔK	入数 Lot	単価 Price
BSF-304E	3	4	6	2	5.5	50	¥27
BSF-304.5E	3	4.5	6	2	5.5	50	¥27
BSF-305E	3	5	6	3	5.5	50	¥27
BSF-305.5E	3	5.5	6	3	5.5	50	¥27
BSF-306E	3	6	6	4	5.5	50	¥27
BSF-306.5E	3	6.5	6	4	5.5	50	¥28
BSF-307E	3	7	6	5	5.5	50	¥28
BSF-307.5E	3	7.5	6	5	5.5	50	¥28
BSF-308E	3	8	6	6	5.5	50	¥28
BSF-308.5E	3	8.5	6	6	5.5	50	¥29
BSF-309E	3	9	6	6	5.5	50	¥29
BSF-309.5E	3	9.5	6	6	5.5	50	¥29
BSF-310E	3	10	6	6	5.5	50	¥29
BSF-311E	3	11	6	6	5.5	50	¥31
BSF-312E	3	12	6	6	5.5	50	¥30
BSF-312.5E	3	12.5	6	6	5.5	50	¥30
BSF-313E	3	13	6	6	5.5	50	¥30
BSF-314E	3	14	6	6	5.5	50	¥31
BSF-315E	3	15	6	6	5.5	50	¥32
BSF-316E	3	16	6	6	5.5	50	¥34
BSF-316.5E	3	16.5	6	6	5.5	50	¥34
BSF-317E	3	17	6	6	5.5	50	¥34
BSF-317.5E	3	17.5	6	6	5.5	50	¥34
BSF-318E	3	18	6	6	5.5	50	¥34
BSF-319E	3	19	6	6	5.5	50	¥35
BSF-320E	3	20	6	6	5.5	50	¥35
BSF-321E	3	21	6	6	5.5	50	¥37
BSF-322E	3	22	6	6	5.5	50	¥37
BSF-323E	3	23	6	6	5.5	50	¥38
BSF-324E	3	24	6	6	5.5	50	¥38
BSF-325E	3	25	6	6	5.5	50	¥34
BSF-326E	3	26	6	6	5.5	50	¥39
BSF-327E	3	27	6	6	5.5	50	¥42
BSF-328E	3	28	6	6	5.5	50	¥44
BSF-329E	3	29	6	6	5.5	50	¥49
BSF-330E	3	30	6	6	5.5	50	¥34
BSF-335E	3	35	6	6	5.5	50	¥39
BSF-340E	3	40	6	6	5.5	50	¥39
BSF-345E	3	45	6	6	5.5	50	¥44
BSF-350E	3	50	6	6	5.5	50	¥44
BSF-355E	3	55	6	6	5.5	50	¥49
BSF-360E	3	60	6	6	5.5	50	¥66
BSF-365E	3	65	6	6	5.5	50	¥74
BSF-370E	3	70	6	6	5.5	50	¥79
BSF-375E	3	75	6	6	5.5	50	¥82
BSF-380E	3	80	6	6	5.5	50	¥84

品番 Product No.	M	L ₁	L ₂	l ₁	ΔK	入数 Lot	単価 Price
BSF-385E	3	85	6	6	5.5	50	¥89
BSF-390E	3	90	6	6	5.5	50	¥94
BSF-395E	3	95	6	6	5.5	50	¥97
BSF-3100E	3	100	6	6	5.5	50	¥99
BSF-406E	4	6	7	3.5	7	50	¥24
BSF-407E	4	7	7	4.5	7	50	¥24
BSF-408E	4	8	7	5.5	7	50	¥24
BSF-409E	4	9	7	6	7	50	¥24
BSF-410E	4	10	7	7.5	7	50	¥29
BSF-411E	4	11	7	7.5	7	50	¥29
BSF-412E	4	12	7	7.5	7	50	¥29
BSF-413E	4	13	7	7.5	7	50	¥29
BSF-414E	4	14	7	7.5	7	50	¥29
BSF-415E	4	15	7	7.5	7	50	¥29
BSF-416E	4	16	7	7.5	7	50	¥29
BSF-417E	4	17	7	7.5	7	50	¥29
BSF-418E	4	18	7	7.5	7	50	¥34
BSF-419E	4	19	7	7.5	7	50	¥34
BSF-420E	4	20	7	7.5	7	50	¥34
BSF-421E	4	21	7	7.5	7	50	¥34
BSF-422E	4	22	7	7.5	7	50	¥34
BSF-423E	4	23	7	7.5	7	50	¥34
BSF-424E	4	24	7	7.5	7	50	¥34
BSF-425E	4	25	7	7.5	7	50	¥39
BSF-426E	4	26	7	7.5	7	50	¥39
BSF-427E	4	27	7	7.5	7	50	¥39
BSF-428E	4	28	7	7.5	7	50	¥39
BSF-429E	4	29	7	7.5	7	50	¥39
BSF-430E	4	30	7	7.5	7	50	¥39
BSF-431E	4	31	7	7.5	7	50	¥39
BSF-432E	4	32	7	7.5	7	50	¥39
BSF-433E	4	33	7	7.5	7	50	¥41
BSF-434E	4	34	7	7.5	7	50	¥44
BSF-435E	4	35	7	7.5	7	50	¥44
BSF-436E	4	36	7	7.5	7	50	¥49
BSF-437E	4	37	7	7.5	7	50	¥51
BSF-438E	4	38	7	7.5	7	50	¥54
BSF-439E	4	39	7	7.5	7	50	¥56
BSF-440E	4	40	7	7.5	7	50	¥59
BSF-441E	4	41	7	7.5	7	50	¥61
BSF-442E	4	42	7	7.5	7	50	¥62
BSF-443E	4	43	7	7.5	7	50	¥64
BSF-444E	4	44	7	7.5	7	50	¥64
BSF-445E	4	45	7	7.5	7	50	¥69
BSF-446E	4	46	7	7.5	7	50	¥69
BSF-447E	4	47	7	7.5	7	50	¥69

品番 Product No.	M	L1	L2	ℓ1	△K	入数 Lot	単価 Price
BSF-448E	4	48	7	7.5	7	50	¥69
BSF-449E	4	49	7	7.5	7	50	¥71
BSF-450E	4	50	7	7.5	7	50	¥74
BSF-451E	4	51	7	7.5	7	50	¥76
BSF-452E	4	52	7	7.5	7	50	¥79
BSF-453E	4	53	7	7.5	7	50	¥79
BSF-454E	4	54	7	7.5	7	50	¥79
BSF-455E	4	55	7	7.5	7	50	¥79
BSF-456E	4	56	7	7.5	7	50	¥84
BSF-457E	4	57	7	7.5	7	50	¥84
BSF-458E	4	58	7	7.5	7	50	¥84
BSF-459E	4	59	7	7.5	7	50	¥89
BSF-460E	4	60	7	7.5	7	50	¥89
BSF-462E	4	62	7	7.5	7	50	¥89
BSF-464E	4	64	7	7.5	7	50	¥94
BSF-465E	4	65	7	7.5	7	50	¥94
BSF-466E	4	66	7	7.5	7	50	¥94
BSF-468E	4	68	7	7.5	7	50	¥94
BSF-470E	4	70	7	7.5	7	50	¥94
BSF-472E	4	72	7	7.5	7	50	¥99
BSF-474E	4	74	7	7.5	7	50	¥99
BSF-475E	4	75	7	7.5	7	50	¥99
BSF-476E	4	76	7	7.5	7	50	¥99
BSF-478E	4	78	7	7.5	7	50	¥99
BSF-480E	4	80	7	7.5	7	50	¥104
BSF-485E	4	85	7	7.5	7	50	¥109
BSF-490E	4	90	7	7.5	7	50	¥114
BSF-495E	4	95	7	7.5	7	50	¥124
BSF-4100E	4	100	7	7.5	7	50	¥134
BSF-4110E	4	110	7	7.5	7	50	¥169
BSF-4120E	4	120	7	7.5	7	50	¥174
BSF-4130E	4	130	7	7.5	7	50	¥189
BSF-4140E	4	140	7	7.5	7	50	¥194
BSF-4150E	4	150	7	7.5	7	50	¥199
BSF-508E	5	8	10	5	8	10	¥64
BSF-510E	5	10	10	7	8	10	¥64
BSF-512E	5	12	10	9	8	10	¥74
BSF-515E	5	15	10	10	8	10	¥74
BSF-518E	5	18	10	10	8	10	¥79
BSF-520E	5	20	10	10	8	10	¥79
BSF-525E	5	25	10	10	8	10	¥79
BSF-530E	5	30	10	10	8	10	¥94
BSF-535E	5	35	10	10	8	10	¥99
BSF-540E	5	40	10	10	8	10	¥104
BSF-545E	5	45	10	10	8	10	¥114
BSF-550E	5	50	10	10	8	10	¥119
BSF-555E	5	55	10	10	8	10	¥124
BSF-560E	5	60	10	10	8	10	¥134
BSF-565E	5	65	10	10	8	10	¥139
BSF-570E	5	70	10	10	8	10	¥144
BSF-575E	5	75	10	10	8	10	¥152
BSF-580E	5	80	10	10	8	10	¥157
BSF-585E	5	85	10	10	8	10	¥159
BSF-590E	5	90	10	10	8	10	¥162
BSF-595E	5	95	10	10	8	10	¥164
BSF-5100E	5	100	10	10	8	10	¥167
BSF-5110E	5	110	10	10	8	10	¥174
BSF-5120E	5	120	10	10	8	10	¥179
BSF-5125E	5	125	10	10	8	10	¥189
BSF-5130E	5	130	10	10	8	10	¥194
BSF-5140E	5	140	10	10	8	10	¥199
BSF-5150E	5	150	10	10	8	10	¥204

品番 Product No.	M	L1	L2	ℓ1	△K	入数 Lot	単価 Price
BSF-610E	6	10	13	7	10	10	¥77
BSF-615E	6	15	13	12	10	10	¥82
BSF-620E	6	20	13	14	10	10	¥87
BSF-625E	6	25	13	14	10	10	¥90
BSF-630E	6	30	13	14	10	10	¥99
BSF-635E	6	35	13	14	10	10	¥104
BSF-640E	6	40	13	14	10	10	¥112
BSF-645E	6	45	13	14	10	10	¥122
BSF-650E	6	50	13	14	10	10	¥127
BSF-655E	6	55	13	14	10	10	¥132
BSF-660E	6	60	13	14	10	10	¥142
BSF-665E	6	65	13	14	10	10	¥144
BSF-670E	6	70	13	14	10	10	¥147
BSF-675E	6	75	13	14	10	10	¥154
BSF-680E	6	80	13	14	10	10	¥164
BSF-685E	6	85	13	14	10	10	¥167
BSF-690E	6	90	13	14	10	10	¥169
BSF-695E	6	95	13	14	10	10	¥172
BSF-6100E	6	100	13	14	10	10	¥174
BSF-6110E	6	110	13	14	10	10	¥179
BSF-6120E	6	120	13	14	10	10	¥184
BSF-6125E	6	125	13	14	10	10	¥194
BSF-6130E	6	130	13	14	10	10	¥204
BSF-6140E	6	140	13	14	10	10	¥209
BSF-6150E	6	150	13	14	10	10	¥214
BSF-850E	8	50	15	17	13	10	¥214
BSF-860E	8	60	15	17	13	10	¥234
BSF-870E	8	70	15	17	13	10	¥254
BSF-880E	8	80	15	17	13	10	¥274
BSF-890E	8	90	15	17	13	10	¥294
BSF-8100E	8	100	15	17	13	10	¥314
BSF-8125E	8	125	15	17	13	10	¥344
BSF-8150E	8	150	15	17	13	10	¥384

六角サポーター(ステンレス)

HEXAGONAL SPACER (STAINLESS)

BSU-300~800 (SUS)

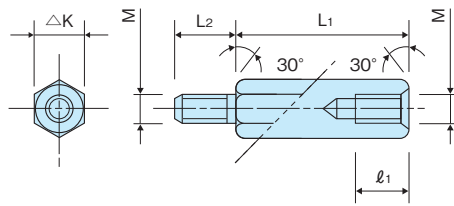

Lの公差/L=60迄±0.1、L=61以上~100迄±0.2、L=110以上±0.3

材質 ●快削ステンレス鋼 (SUS303)

表面処理 ●脱脂

Material ●Free-cutting stainless steel (SUS303)

Finish ●Degreasing

※市販品につき、ケース単位(入数)でのご注文をお願い致します。

品番 Product No.	M	L ₁	L ₂	φ ₁	ΔK	入数 Lot	単価 Price
BSU-304	3	4	6	2	5.5	50	¥56
BSU-304.5	3	4.5	6	2	5.5	50	¥56
BSU-305	3	5	6	3	5.5	50	¥56
BSU-305.5	3	5.5	6	3	5.5	50	¥56
BSU-306	3	6	6	4	5.5	50	¥56
BSU-306.5	3	6.5	6	4	5.5	50	¥56
BSU-307	3	7	6	5	5.5	50	¥56
BSU-307.5	3	7.5	6	5.5	5.5	50	¥56
BSU-308	3	8	6	6	5.5	50	¥51
BSU-308.5	3	8.5	6	6	5.5	50	¥56
BSU-309	3	9	6	6	5.5	50	¥56
BSU-309.5	3	9.5	6	6	5.5	50	¥56
BSU-310	3	10	6	6	5.5	50	¥51
BSU-310.5	3	10.5	6	6	5.5	50	¥56
BSU-311	3	11	6	6	5.5	50	¥62
BSU-311.5	3	11.5	6	6	5.5	50	¥62
BSU-312	3	12	6	6	5.5	50	¥62
BSU-312.5	3	12.5	6	6	5.5	50	¥67
BSU-313	3	13	6	6	5.5	50	¥67
BSU-313.5	3	13.5	6	6	5.5	50	¥67
BSU-314	3	14	6	6	5.5	50	¥67
BSU-314.5	3	14.5	6	6	5.5	50	¥67
BSU-315	3	15	6	6	5.5	50	¥65
BSU-315.5	3	15.5	6	6	5.5	50	¥67
BSU-316	3	16	6	6	5.5	50	¥73
BSU-316.5	3	16.5	6	6	5.5	50	¥73
BSU-317	3	17	6	6	5.5	50	¥73
BSU-317.5	3	17.5	6	6	5.5	50	¥73
BSU-318	3	18	6	6	5.5	50	¥73
BSU-318.5	3	18.5	6	6	5.5	50	¥73
BSU-319	3	19	6	6	5.5	50	¥73
BSU-319.5	3	19.5	6	6	5.5	50	¥73
BSU-320	3	20	6	6	5.5	50	¥69
BSU-321	3	21	6	6	5.5	50	¥71
BSU-322	3	22	6	6	5.5	50	¥71
BSU-323	3	23	6	6	5.5	50	¥74
BSU-324	3	24	6	6	5.5	50	¥74
BSU-325	3	25	6	6	5.5	50	¥75
BSU-326	3	26	6	6	5.5	50	¥78
BSU-327	3	27	6	6	5.5	50	¥78
BSU-328	3	28	6	6	5.5	50	¥81

品番 Product No.	M	L ₁	L ₂	φ ₁	ΔK	入数 Lot	単価 Price
BSU-329	3	29	6	6	5.5	50	¥81
BSU-330	3	30	6	6	5.5	50	¥89
BSU-331	3	31	6	6	5.5	50	¥95
BSU-332	3	32	6	6	5.5	50	¥95
BSU-333	3	33	6	6	5.5	50	¥95
BSU-334	3	34	6	6	5.5	50	¥95
BSU-335	3	35	6	6	5.5	50	¥95
BSU-336	3	36	6	6	5.5	50	¥100
BSU-337	3	37	6	6	5.5	50	¥100
BSU-338	3	38	6	6	5.5	50	¥100
BSU-339	3	39	6	6	5.5	50	¥100
BSU-340	3	40	6	6	5.5	50	¥100
BSU-341	3	41	6	6	5.5	50	¥109
BSU-342	3	42	6	6	5.5	50	¥109
BSU-343	3	43	6	6	5.5	50	¥109
BSU-344	3	44	6	6	5.5	50	¥109
BSU-345	3	45	6	6	5.5	50	¥106
BSU-346	3	46	6	6	5.5	50	¥113
BSU-347	3	47	6	6	5.5	50	¥113
BSU-348	3	48	6	6	5.5	50	¥113
BSU-349	3	49	6	6	5.5	50	¥113
BSU-350	3	50	6	6	5.5	50	¥111
BSU-351	3	51	6	6	5.5	50	¥124
BSU-352	3	52	6	6	5.5	50	¥124
BSU-353	3	53	6	6	5.5	50	¥124
BSU-354	3	54	6	6	5.5	50	¥124
BSU-355	3	55	6	6	5.5	50	¥122
BSU-356	3	56	6	6	5.5	50	¥141
BSU-357	3	57	6	6	5.5	50	¥141
BSU-358	3	58	6	6	5.5	50	¥141
BSU-359	3	59	6	6	5.5	50	¥141
BSU-360	3	60	6	6	5.5	50	¥139
BSU-365	3	65	6	6	5.5	50	¥155
BSU-370	3	70	6	6	5.5	50	¥166
BSU-375	3	75	6	6	5.5	50	¥177
BSU-380	3	80	6	6	5.5	50	¥183
BSU-385	3	85	6	6	5.5	50	¥188
BSU-390	3	90	6	6	5.5	50	¥199
BSU-395	3	95	6	6	5.5	50	¥205
BSU-3100	3	100	6	6	5.5	50	¥216

品番 Product No.	M	L ₁	L ₂	ℓ ₁	△K	入数 Lot	単価 Price
BSU-406	4	6	7	3.5	7	50	¥67
BSU-406.5	4	6.5	7	3.5	7	50	¥67
BSU-407	4	7	7	4.5	7	50	¥67
BSU-407.5	4	7.5	7	4.5	7	50	¥67
BSU-408	4	8	7	5.5	7	50	¥67
BSU-408.5	4	8.5	7	5.5	7	50	¥67
BSU-409	4	9	7	6	7	50	¥73
BSU-409.5	4	9.5	7	6	7	50	¥73
BSU-410	4	10	7	7	7	50	¥67
BSU-410.5	4	10.5	7	7	7	50	¥73
BSU-411	4	11	7	8	7	50	¥73
BSU-411.5	4	11.5	7	8	7	50	¥73
BSU-412	4	12	7	8	7	50	¥73
BSU-412.5	4	12.5	7	8	7	50	¥73
BSU-413	4	13	7	8	7	50	¥84
BSU-413.5	4	13.5	7	8	7	50	¥84
BSU-414	4	14	7	8	7	50	¥89
BSU-414.5	4	14.5	7	8	7	50	¥89
BSU-415	4	15	7	8	7	50	¥84
BSU-415.5	4	15.5	7	8	7	50	¥89
BSU-416	4	16	7	8	7	50	¥95
BSU-416.5	4	16.5	7	8	7	50	¥95
BSU-417	4	17	7	8	7	50	¥95
BSU-417.5	4	17.5	7	8	7	50	¥95
BSU-418	4	18	7	8	7	50	¥95
BSU-418.5	4	18.5	7	8	7	50	¥95
BSU-419	4	19	7	8	7	50	¥95
BSU-419.5	4	19.5	7	8	7	50	¥95
BSU-420	4	20	7	8	7	50	¥89
BSU-421	4	21	7	8	7	50	¥106
BSU-422	4	22	7	8	7	50	¥106
BSU-423	4	23	7	8	7	50	¥106
BSU-424	4	24	7	8	7	50	¥106
BSU-425	4	25	7	8	7	50	¥106
BSU-426	4	26	7	8	7	50	¥122
BSU-427	4	27	7	8	7	50	¥122
BSU-428	4	28	7	8	7	50	¥122
BSU-429	4	29	7	8	7	50	¥128
BSU-430	4	30	7	8	7	50	¥117
BSU-431	4	31	7	8	7	50	¥128
BSU-432	4	32	7	8	7	50	¥128
BSU-433	4	33	7	8	7	50	¥128
BSU-434	4	34	7	8	7	50	¥128
BSU-435	4	35	7	8	7	50	¥128
BSU-436	4	36	7	8	7	50	¥139
BSU-437	4	37	7	8	7	50	¥139
BSU-438	4	38	7	8	7	50	¥139
BSU-439	4	39	7	8	7	50	¥139
BSU-440	4	40	7	8	7	50	¥139
BSU-441	4	41	7	8	7	50	¥139
BSU-442	4	42	7	8	7	50	¥139
BSU-443	4	43	7	8	7	50	¥139
BSU-444	4	44	7	8	7	50	¥139
BSU-445	4	45	7	8	7	50	¥139
BSU-446	4	46	7	8	7	50	¥150
BSU-447	4	47	7	8	7	50	¥150
BSU-448	4	48	7	8	7	50	¥150
BSU-449	4	49	7	8	7	50	¥150
BSU-450	4	50	7	8	7	50	¥150

品番 Product No.	M	L ₁	L ₂	ℓ ₁	△K	入数 Lot	単価 Price
BSU-451	4	51	7	8	7	50	¥161
BSU-452	4	52	7	8	7	50	¥161
BSU-453	4	53	7	8	7	50	¥161
BSU-454	4	54	7	8	7	50	¥161
BSU-455	4	55	7	8	7	50	¥161
BSU-456	4	56	7	8	7	50	¥177
BSU-457	4	57	7	8	7	50	¥177
BSU-458	4	58	7	8	7	50	¥177
BSU-459	4	59	7	8	7	50	¥177
BSU-460	4	60	7	8	7	50	¥177
BSU-462	4	62	7	8	7	50	¥194
BSU-464	4	64	7	8	7	50	¥194
BSU-465	4	65	7	8	7	50	¥194
BSU-466	4	66	7	8	7	50	¥205
BSU-468	4	68	7	8	7	50	¥205
BSU-470	4	70	7	8	7	50	¥199
BSU-472	4	72	7	8	7	50	¥210
BSU-474	4	74	7	8	7	50	¥210
BSU-475	4	75	7	8	7	50	¥210
BSU-476	4	76	7	8	7	50	¥227
BSU-478	4	78	7	8	7	50	¥227
BSU-480	4	80	7	8	7	50	¥216
BSU-485	4	85	7	8	7	50	¥221
BSU-490	4	90	7	8	7	50	¥232
BSU-495	4	95	7	8	7	50	¥243
BSU-4100	4	100	7	8	7	50	¥265
BSU-4110	4	110	7	8	7	50	¥287
BSU-4120	4	120	7	8	7	50	¥309
BSU-4130	4	130	7	8	7	50	¥326
BSU-4140	4	140	7	8	7	50	¥353
BSU-4150	4	150	7	8	7	50	¥364
BSU-508	5	8	10	5	8	10	¥100
BSU-510	5	10	10	7	8	10	¥100
BSU-512	5	12	10	9	8	10	¥100
BSU-515	5	15	10	10	8	10	¥111
BSU-518	5	18	10	10	8	10	¥111
BSU-520	5	20	10	10	8	10	¥111
BSU-525	5	25	10	10	8	10	¥144
BSU-530	5	30	10	10	8	10	¥155
BSU-535	5	35	10	10	8	10	¥172
BSU-540	5	40	10	10	8	10	¥172
BSU-545	5	45	10	10	8	10	¥183
BSU-550	5	50	10	10	8	10	¥194
BSU-555	5	55	10	10	8	10	¥199
BSU-560	5	60	10	10	8	10	¥210
BSU-565	5	65	10	10	8	10	¥232
BSU-570	5	70	10	10	8	10	¥265
BSU-575	5	75	10	10	8	10	¥276
BSU-580	5	80	10	10	8	10	¥309
BSU-585	5	85	10	10	8	10	¥320
BSU-590	5	90	10	10	8	10	¥331
BSU-595	5	95	10	10	8	10	¥364
BSU-5100	5	100	10	10	8	10	¥386
BSU-5110	5	110	10	10	8	10	¥419
BSU-5120	5	120	10	10	8	10	¥441
BSU-5125	5	125	10	10	8	10	¥496
BSU-5130	5	130	10	10	8	10	¥529
BSU-5140	5	140	10	10	8	10	¥584
BSU-5150	5	150	10	10	8	10	¥606

六角サポーター(ステンレス)

HEXAGONAL SPACER (STAINLESS)

BSU-300~800 (SUS)

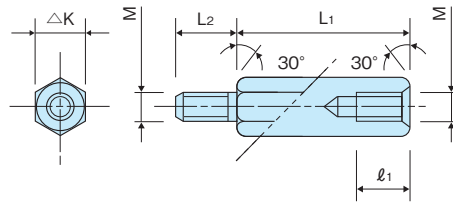

Lの公差/L=60迄±0.1、L=61以上~100迄±0.2、L=110以上±0.3

材質 ●快削ステンレス鋼 (SUS303)

表面処理 ●脱脂

Material ●Free-cutting stainless steel (SUS303)

Finish ●Degreasing

※市販品につき、ケース単位(入数)でのご注文をお願い致します。

品番 Product No.	M	L ₁	L ₂	φ ₁	ΔK	入数 Lot	単価 Price
BSU-610	6	10	13	7	10	10	¥144
BSU-615	6	15	13	12	10	10	¥150
BSU-620	6	20	13	14	10	10	¥155
BSU-625	6	25	13	14	10	10	¥161
BSU-630	6	30	13	14	10	10	¥177
BSU-635	6	35	13	14	10	10	¥210
BSU-640	6	40	13	14	10	10	¥221
BSU-645	6	45	13	14	10	10	¥254
BSU-650	6	50	13	14	10	10	¥271
BSU-655	6	55	13	14	10	10	¥293
BSU-660	6	60	13	14	10	10	¥353
BSU-665	6	65	13	14	10	10	¥364
BSU-670	6	70	13	14	10	10	¥386
BSU-675	6	75	13	14	10	10	¥397
BSU-680	6	80	13	14	10	10	¥419
BSU-685	6	85	13	14	10	10	¥441
BSU-690	6	90	13	14	10	10	¥452

品番 Product No.	M	L ₁	L ₂	φ ₁	ΔK	入数 Lot	単価 Price
BSU-695	6	95	13	14	10	10	¥474
BSU-6100	6	100	13	14	10	10	¥496
BSU-6110	6	110	13	14	10	10	¥518
BSU-6120	6	120	13	14	10	10	¥529
BSU-6125	6	125	13	14	10	10	¥551
BSU-6130	6	130	13	14	10	10	¥573
BSU-6140	6	140	13	14	10	10	¥595
BSU-6150	6	150	13	14	10	10	¥628
BSU-850	8	50	15	17	13	10	¥901
BSU-860	8	60	15	17	13	10	¥944
BSU-870	8	70	15	17	13	10	¥986
BSU-880	8	80	15	17	13	10	¥1,029
BSU-890	8	90	15	17	13	10	¥1,071
BSU-8100	8	100	15	17	13	10	¥1,114
BSU-8125	8	125	15	17	13	10	¥1,156
BSU-8150	8	150	15	17	13	10	¥1,199

六角サポーター(黄銅)

HEXAGONAL SPACER (BRASS)

BSB-300E~500E (BS)

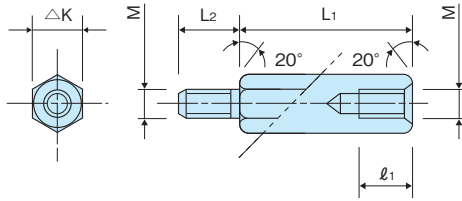

Lの公差/L=60迄±0.1、L=61以上~100迄±0.2、L=110以上±0.3

材質 ●快削黄銅 (C3604BD)
表面処理 ●ニッケルメッキ

Material ●Free-cutting brass (C3604BD)
Finish ●Nickel plating

※市販品につき、ケース単位(入数)でのご注文をお願い致します。

品番 Product No.	M	L ₁	L ₂	φ ₁	ΔK	入数 Lot	単価 Price
BSB-304E	3	4	6	2.5	5.5	50	¥17
BSB-304.5E	3	4.5	6	2.5	5.5	50	¥17
BSB-305E	3	5	6	3.5	5.5	50	¥15
BSB-305.5E	3	5.5	6	3.5	5.5	50	¥17
BSB-306E	3	6	6	4	5.5	50	¥15
BSB-306.5E	3	6.5	6	4	5.5	50	¥17
BSB-307E	3	7	6	5	5.5	50	¥17
BSB-307.5E	3	7.5	6	5.5	5.5	50	¥19
BSB-308E	3	8	6	6	5.5	50	¥14
BSB-308.5E	3	8.5	6	6	5.5	50	¥19
BSB-309E	3	9	6	6	5.5	50	¥19
BSB-309.5E	3	9.5	6	6	5.5	50	¥20
BSB-310E	3	10	6	6	5.5	50	¥15
BSB-310.5E	3	10.5	6	6	5.5	50	¥20
BSB-311E	3	11	6	6	5.5	50	¥20
BSB-311.5E	3	11.5	6	6	5.5	50	¥20
BSB-312E	3	12	6	6	5.5	50	¥15
BSB-312.5E	3	12.5	6	6	5.5	50	¥20
BSB-313E	3	13	6	6	5.5	50	¥20
BSB-313.5E	3	13.5	6	6	5.5	50	¥20
BSB-314E	3	14	6	6	5.5	50	¥22
BSB-314.5E	3	14.5	6	6	5.5	50	¥22
BSB-315E	3	15	6	6	5.5	50	¥17
BSB-315.5E	3	15.5	6	6	5.5	50	¥22
BSB-316E	3	16	6	6	5.5	50	¥24
BSB-316.5E	3	16.5	6	6	5.5	50	¥24
BSB-317E	3	17	6	6	5.5	50	¥24
BSB-317.5E	3	17.5	6	6	5.5	50	¥24
BSB-318E	3	18	6	6	5.5	50	¥24
BSB-318.5E	3	18.5	6	6	5.5	50	¥24
BSB-319E	3	19	6	6	5.5	50	¥26
BSB-319.5E	3	19.5	6	6	5.5	50	¥26
BSB-320E	3	20	6	6	5.5	50	¥19
BSB-321E	3	21	6	6	5.5	50	¥29
BSB-322E	3	22	6	6	5.5	50	¥29
BSB-323E	3	23	6	6	5.5	50	¥29
BSB-324E	3	24	6	6	5.5	50	¥29
BSB-325E	3	25	6	6	5.5	50	¥29
BSB-326E	3	26	6	6	5.5	50	¥34
BSB-327E	3	27	6	6	5.5	50	¥34
BSB-328E	3	28	6	6	5.5	50	¥34
BSB-329E	3	29	6	6	5.5	50	¥34
BSB-330E	3	30	6	6	5.5	50	¥32
BSB-331E	3	31	6	6	5.5	50	¥35
BSB-332E	3	32	6	6	5.5	50	¥35
BSB-333E	3	33	6	6	5.5	50	¥37
BSB-334E	3	34	6	6	5.5	50	¥37
BSB-335E	3	35	6	6	5.5	50	¥34
BSB-336E	3	36	6	6	5.5	50	¥38
BSB-337E	3	37	6	6	5.5	50	¥38

品番 Product No.	M	L ₁	L ₂	φ ₁	ΔK	入数 Lot	単価 Price
BSB-338E	3	38	6	6	5.5	50	¥39
BSB-339E	3	39	6	6	5.5	50	¥40
BSB-340E	3	40	6	6	5.5	50	¥36
BSB-341E	3	41	6	6	5.5	50	¥41
BSB-342E	3	42	6	6	5.5	50	¥41
BSB-343E	3	43	6	6	5.5	50	¥44
BSB-344E	3	44	6	6	5.5	50	¥46
BSB-345E	3	45	6	6	5.5	50	¥44
BSB-346E	3	46	6	6	5.5	50	¥46
BSB-347E	3	47	6	6	5.5	50	¥46
BSB-348E	3	48	6	6	5.5	50	¥47
BSB-349E	3	49	6	6	5.5	50	¥47
BSB-350E	3	50	6	6	5.5	50	¥44
BSB-351E	3	51	6	6	5.5	50	¥48
BSB-352E	3	52	6	6	5.5	50	¥49
BSB-353E	3	53	6	6	5.5	50	¥51
BSB-354E	3	54	6	6	5.5	50	¥53
BSB-355E	3	55	6	6	5.5	50	¥49
BSB-356E	3	56	6	6	5.5	50	¥54
BSB-357E	3	57	6	6	5.5	50	¥54
BSB-358E	3	58	6	6	5.5	50	¥55
BSB-359E	3	59	6	6	5.5	50	¥55
BSB-360E	3	60	6	6	5.5	50	¥52
BSB-365E	3	65	6	6	5.5	50	¥63
BSB-370E	3	70	6	6	5.5	50	¥71
BSB-375E	3	75	6	6	5.5	50	¥79
BSB-380E	3	80	6	6	5.5	50	¥86
BSB-385E	3	85	6	6	5.5	50	¥89
BSB-390E	3	90	6	6	5.5	50	¥91
BSB-395E	3	95	6	6	5.5	50	¥96
BSB-3100E	3	100	6	6	5.5	50	¥100
BSB-406E	4	6	7	3.5	7	50	¥23
BSB-406.5E	4	6.5	7	3.5	7	50	¥23
BSB-407E	4	7	7	4.5	7	50	¥23
BSB-407.5E	4	7.5	7	4.5	7	50	¥23
BSB-408E	4	8	7	5.5	7	50	¥23
BSB-408.5E	4	8.5	7	5.5	7	50	¥23
BSB-409E	4	9	7	6	7	50	¥26
BSB-409.5E	4	9.5	7	6	7	50	¥26
BSB-410E	4	10	7	7	7	50	¥24
BSB-410.5E	4	10.5	7	7	7	50	¥26
BSB-411E	4	11	7	8	7	50	¥29
BSB-411.5E	4	11.5	7	8	7	50	¥29
BSB-412E	4	12	7	8	7	50	¥30
BSB-412.5E	4	12.5	7	8	7	50	¥30
BSB-413E	4	13	7	8	7	50	¥30
BSB-413.5E	4	13.5	7	8	7	50	¥30
BSB-414E	4	14	7	8	7	50	¥30
BSB-414.5E	4	14.5	7	8	7	50	¥30
BSB-415E	4	15	7	8	7	50	¥26

六角サポーター (黄銅)

HEXAGONAL SPACER (BRASS)

BSB-300E~500E (BS)

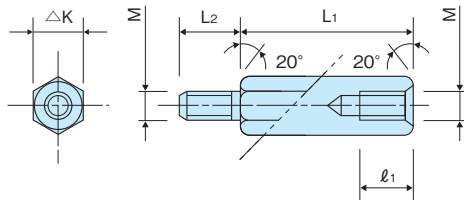

Lの公差/L=60迄±0.1、L=61以上~100迄±0.2、L=110以上±0.3

材質 ●快削黄銅 (C3604BD)

表面处理 ●ニッケルメッキ

Material ●Free-cutting brass (C3604BD)

Finish ●Nickel plating

※市販品につき、ケース単位(入数)でのご注文をお願い致します。

品番 Product No.	M	L ₁	L ₂	φ ₁	ΔK	入数 Lot	単価 Price
BSB-415.5E	4	15.5	7	8	7	50	¥30
BSB-416E	4	16	7	8	7	50	¥33
BSB-416.5E	4	16.5	7	8	7	50	¥33
BSB-417E	4	17	7	8	7	50	¥35
BSB-417.5E	4	17.5	7	8	7	50	¥35
BSB-418E	4	18	7	8	7	50	¥36
BSB-418.5E	4	18.5	7	8	7	50	¥36
BSB-419E	4	19	7	8	7	50	¥37
BSB-419.5E	4	19.5	7	8	7	50	¥37
BSB-420E	4	20	7	8	7	50	¥32
BSB-421E	4	21	7	8	7	50	¥40
BSB-422E	4	22	7	8	7	50	¥40
BSB-423E	4	23	7	8	7	50	¥40
BSB-424E	4	24	7	8	7	50	¥40
BSB-425E	4	25	7	8	7	50	¥35
BSB-426E	4	26	7	8	7	50	¥42
BSB-427E	4	27	7	8	7	50	¥43
BSB-428E	4	28	7	8	7	50	¥43
BSB-429E	4	29	7	8	7	50	¥44
BSB-430E	4	30	7	8	7	50	¥40
BSB-431E	4	31	7	8	7	50	¥44
BSB-432E	4	32	7	8	7	50	¥44
BSB-433E	4	33	7	8	7	50	¥44
BSB-434E	4	34	7	8	7	50	¥44
BSB-435E	4	35	7	8	7	50	¥42
BSB-436E	4	36	7	8	7	50	¥47
BSB-437E	4	37	7	8	7	50	¥47
BSB-438E	4	38	7	8	7	50	¥47
BSB-439E	4	39	7	8	7	50	¥47
BSB-440E	4	40	7	8	7	50	¥45
BSB-441E	4	41	7	8	7	50	¥49
BSB-442E	4	42	7	8	7	50	¥49
BSB-443E	4	43	7	8	7	50	¥49
BSB-444E	4	44	7	8	7	50	¥49
BSB-445E	4	45	7	8	7	50	¥50
BSB-446E	4	46	7	8	7	50	¥54
BSB-447E	4	47	7	8	7	50	¥54
BSB-448E	4	48	7	8	7	50	¥54
BSB-449E	4	49	7	8	7	50	¥54
BSB-450E	4	50	7	8	7	50	¥50
BSB-451E	4	51	7	8	7	50	¥61
BSB-452E	4	52	7	8	7	50	¥61
BSB-453E	4	53	7	8	7	50	¥61
BSB-454E	4	54	7	8	7	50	¥61
BSB-455E	4	55	7	8	7	50	¥57
BSB-456E	4	56	7	8	7	50	¥66
BSB-457E	4	57	7	8	7	50	¥66
BSB-458E	4	58	7	8	7	50	¥66
BSB-459E	4	59	7	8	7	50	¥66
BSB-460E	4	60	7	8	7	50	¥61

品番 Product No.	M	L ₁	L ₂	φ ₁	ΔK	入数 Lot	単価 Price
BSB-462E	4	62	7	8	7	50	¥71
BSB-464E	4	64	7	8	7	50	¥71
BSB-465E	4	65	7	8	7	50	¥66
BSB-466E	4	66	7	8	7	50	¥76
BSB-468E	4	68	7	8	7	50	¥81
BSB-470E	4	70	7	8	7	50	¥81
BSB-472E	4	72	7	8	7	50	¥91
BSB-474E	4	74	7	8	7	50	¥91
BSB-475E	4	75	7	8	7	50	¥86
BSB-476E	4	76	7	8	7	50	¥91
BSB-478E	4	78	7	8	7	50	¥91
BSB-480E	4	80	7	8	7	50	¥90
BSB-485E	4	85	7	8	7	50	¥93
BSB-490E	4	90	7	8	7	50	¥96
BSB-495E	4	95	7	8	7	50	¥100
BSB-4100E	4	100	7	8	7	50	¥104
BSB-4110E	4	110	7	8	7	50	¥159
BSB-4120E	4	120	7	8	7	50	¥179
BSB-4130E	4	130	7	8	7	50	¥189
BSB-4140E	4	140	7	8	7	50	¥209
BSB-4150E	4	150	7	8	7	50	¥219
BSB-508E	5	8	10	5	8	10	¥41
BSB-510E	5	10	10	7	8	10	¥43
BSB-512E	5	12	10	9	8	10	¥44
BSB-515E	5	15	10	10	8	10	¥45
BSB-518E	5	18	10	10	8	10	¥47
BSB-520E	5	20	10	10	8	10	¥48
BSB-525E	5	25	10	10	8	10	¥51
BSB-530E	5	30	10	10	8	10	¥55
BSB-535E	5	35	10	10	8	10	¥58
BSB-540E	5	40	10	10	8	10	¥63
BSB-545E	5	45	10	10	8	10	¥73
BSB-550E	5	50	10	10	8	10	¥77
BSB-555E	5	55	10	10	8	10	¥83
BSB-560E	5	60	10	10	8	10	¥83
BSB-565E	5	65	10	10	8	10	¥88
BSB-570E	5	70	10	10	8	10	¥93
BSB-575E	5	75	10	10	8	10	¥101
BSB-580E	5	80	10	10	8	10	¥103
BSB-585E	5	85	10	10	8	10	¥114
BSB-590E	5	90	10	10	8	10	¥116
BSB-595E	5	95	10	10	8	10	¥118
BSB-5100E	5	100	10	10	8	10	¥118
BSB-5110E	5	110	10	10	8	10	¥151
BSB-5120E	5	120	10	10	8	10	¥176
BSB-5125E	5	125	10	10	8	10	¥196
BSB-5130E	5	130	10	10	8	10	¥206
BSB-5140E	5	140	10	10	8	10	¥211
BSB-5150E	5	150	10	10	8	10	¥216

六角サポーター(ジュラコン)

HEXAGONAL SPACER (POLYACETAL)

BS-300E (POM)

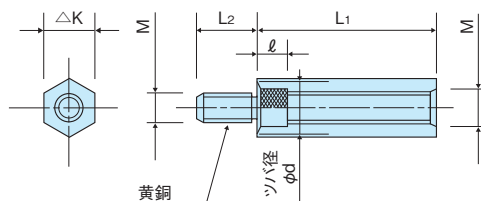

Lの公差/L=15迄±0.1、L=16以上〜±0.2

- 材質**
- 本体/ジュラコン(POM)
 - オネジ部/快削黄銅(C3604BD)
- 表面処理**
- オネジ部/ニッケルメッキ
- 色**
- 本体/乳白色
- 熱変形温度**
- 本体/1.82MPa…110°
- UL規格**
- 本体/UL94-HB(材料)

- Material**
- Body/Polyacetal(POM)
 - Male screw/Free-cutting brass(C3604BD)
- Finish**
- Male screw/Nickel plating
- Color**
- Body/Milky-white
- Heat deflection temperature**
- Body/1.82MPa…110°
- UL standards**
- Body/UL94-HB(Material)

※市販品につき、ケース単位(入数)でのご注文をお願い致します。

品番 Product No.	M	L ₁	L ₂	ℓ	ツバ径 φd	ΔK	入数 Lot	単価 Price
BS-306E	3	6	6	3.2	4	5.5	50	¥19
BS-306.5E	3	6.5	6	3.2	4	5.5	50	¥21
BS-307E	3	7	6	3.2	4	5.5	50	¥19
BS-307.5E	3	7.5	6	3.2	4	5.5	50	¥23
BS-308E	3	8	6	4	4	5.5	50	¥19
BS-308.5E	3	8.5	6	4	4	5.5	50	¥22
BS-309E	3	9	6	4	4	5.5	50	¥19
BS-309.5E	3	9.5	6	4	4	5.5	50	¥23
BS-310E	3	10	6	4	4	5.5	50	¥19
BS-311E	3	11	6	4	4	5.5	50	¥24
BS-312E	3	12	6	4	4	5.5	50	¥19
BS-312.5E	3	12.5	6	4	4	5.5	50	¥24
BS-313E	3	13	6	4	4	5.5	50	¥22
BS-314E	3	14	6	4	4	5.5	50	¥25
BS-315E	3	15	6	4	4	5.5	50	¥20
BS-316E	3	16	6	4	4	5.5	50	¥27
BS-316.5E	3	16.5	6	4	4	5.5	50	¥27
BS-317E	3	17	6	4	4	5.5	50	¥27
BS-317.5E	3	17.5	6	4	4	5.5	50	¥27
BS-318E	3	18	6	4	4	5.5	50	¥25
BS-319E	3	19	6	4	4	5.5	50	¥28
BS-320E	3	20	6	4	4	5.5	50	¥22
BS-321E	3	21	6	4	4	5.5	50	¥30

品番 Product No.	M	L ₁	L ₂	ℓ	ツバ径 φd	ΔK	入数 Lot	単価 Price
BS-322E	3	22	6	4	4	5.5	50	¥30
BS-323E	3	23	6	4	4	5.5	50	¥30
BS-324E	3	24	6	4	4	5.5	50	¥30
BS-325E	3	25	6	4	4	5.5	50	¥28
BS-326E	3	26	6	4	4	5.5	50	¥34
BS-327E	3	27	6	4	4	5.5	50	¥34
BS-328E	3	28	6	4	4	5.5	50	¥34
BS-329E	3	29	6	4	4	5.5	50	¥34
BS-330E	3	30	6	4	4	5.5	50	¥30
BS-331E	3	31	6	4	4	5.5	50	¥32
BS-332E	3	32	6	4	4	5.5	50	¥32
BS-333E	3	33	6	4	4	5.5	50	¥32
BS-334E	3	34	6	4	4	5.5	50	¥33
BS-335E	3	35	6	4	4	5.5	50	¥32
BS-336E	3	36	6	4	4	5.5	50	¥34
BS-337E	3	37	6	4	4	5.5	50	¥35
BS-338E	3	38	6	4	4	5.5	50	¥35
BS-339E	3	39	6	4	4	5.5	50	¥37
BS-340E	3	40	6	4	4	5.5	50	¥35
BS-345E	3	45	6	4	4	5.5	50	¥38
BS-350E	3	50	6	4	4	5.5	50	¥40
BS-355E	3	55	6	4	4	5.5	50	¥44
BS-360E	3	60	6	4	4	5.5	50	¥45

六角サポーター(ジュラコン)

HEXAGONAL SPACER (POLYACETAL)

BS-400E (POM)

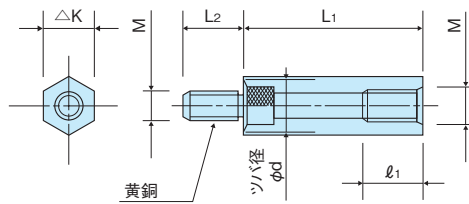

Lの公差/L=15迄±0.1、L=16以上~100迄±0.2、L=110以上±0.3

- 材質** ●本体/ジュラコン(POM)
●オネジ部/快削黄銅(C3604BD)
- 表面処理** ●オネジ部/ニッケルメッキ
- 色** ●本体/乳白色
- 熱変形温度** ●本体/1.82MPa...110°
- UL規格** ●本体/UL94-HB(材料)
-
- Material** ●Body/Polyacetal (POM)
●Male screw/Free-cutting brass (C3604BD)
- Finish** ●Male screw/Nickel plating
- Color** ●Body/Milky-white
- Heat deflection temperature** ●Body/1.82MPa...110°
- UL standards** ●Body/UL94-HB (Material)

※市販品につき、ケース単位(入数)でのご注文をお願い致します。

品番 Product No.	M	L ₁	L ₂	φ ₁	ツバ径 φd	ΔK	入数 Lot	単価 Price
BS-408E	4	8	8	3.8	5	7	50	¥27
BS-409E	4	9	8	4.8	5	7	50	¥27
BS-410E	4	10	8	5.5	5	7	50	¥27
BS-411E	4	11	8	6.5	5	7	50	¥27
BS-412E	4	12	8	7.5	5	7	50	¥27
BS-413E	4	13	8	8.5	5	7	50	¥27
BS-414E	4	14	8	9.5	5	7	50	¥28
BS-415E	4	15	8	10.5	5	7	50	¥28
BS-416E	4	16	8	11.5	5	7	50	¥29
BS-417E	4	17	8	12.5	5	7	50	¥30
BS-418E	4	18	8	13.5	5	7	50	¥30
BS-419E	4	19	8	14.5	5	7	50	¥30
BS-420E	4	20	8	15.5	5	7	50	¥30
BS-421E	4	21	8	16.5	5	7	50	¥32
BS-422E	4	22	8	17.5	5	7	50	¥33
BS-423E	4	23	8	18.5	5	7	50	¥34
BS-424E	4	24	8	19.5	5	7	50	¥34
BS-425E	4	25	8	20.5	5	7	50	¥33
BS-426E	4	26	8	21.5	5	7	50	¥35
BS-427E	4	27	8	22.5	5	7	50	¥36
BS-428E	4	28	8	23.5	5	7	50	¥36
BS-429E	4	29	8	24.5	5	7	50	¥36
BS-430E	4	30	8	25.5	5	7	50	¥35
BS-431E	4	31	8	26.5	5	7	50	¥43
BS-432E	4	32	8	27.5	5	7	50	¥43
BS-433E	4	33	8	28.5	5	7	50	¥43
BS-434E	4	34	8	29.5	5	7	50	¥43
BS-435E	4	35	8	30.5	5	7	50	¥39
BS-436E	4	36	8	31.5	5	7	50	¥45
BS-437E	4	37	8	32.5	5	7	50	¥45
BS-438E	4	38	8	33.5	5	7	50	¥45
BS-439E	4	39	8	34.5	5	7	50	¥45
BS-440E	4	40	8	35.5	5	7	50	¥41
BS-441E	4	41	8	36.5	5	7	50	¥48
BS-442E	4	42	8	37.5	5	7	50	¥48
BS-443E	4	43	8	38.5	5	7	50	¥48
BS-444E	4	44	8	39.5	5	7	50	¥48

品番 Product No.	M	L ₁	L ₂	φ ₁	ツバ径 φd	ΔK	入数 Lot	単価 Price
BS-445E	4	45	8	40.5	5	7	50	¥46
BS-446E	4	46	8	41.5	5	7	50	¥52
BS-447E	4	47	8	42.5	5	7	50	¥52
BS-448E	4	48	8	43.5	5	7	50	¥52
BS-449E	4	49	8	44.5	5	7	50	¥52
BS-450E	4	50	8	45.5	5	7	50	¥48
BS-451E	4	51	8	46.5	5	7	50	¥55
BS-452E	4	52	8	47.5	5	7	50	¥55
BS-453E	4	53	8	48.5	5	7	50	¥55
BS-454E	4	54	8	49.5	5	7	50	¥55
BS-455E	4	55	8	50.5	5	7	50	¥51
BS-456E	4	56	8	51.5	5	7	50	¥59
BS-457E	4	57	8	52.5	5	7	50	¥59
BS-458E	4	58	8	53.5	5	7	50	¥59
BS-459E	4	59	8	54.5	5	7	50	¥59
BS-460E	4	60	8	55.5	5	7	50	¥51
BS-462E	4	62	8	57.5	5	7	50	¥59
BS-464E	4	64	8	59.5	5	7	50	¥59
BS-465E	4	65	8	60.5	5	7	50	¥61
BS-466E	4	66	8	8	5	7	50	¥65
BS-468E	4	68	8	8	5	7	50	¥65
BS-470E	4	70	8	8	5	7	50	¥66
BS-472E	4	72	8	8	5	7	50	¥69
BS-474E	4	74	8	8	5	7	50	¥69
BS-475E	4	75	8	8	5	7	50	¥68
BS-476E	4	76	8	8	5	7	50	¥77
BS-478E	4	78	8	8	5	7	50	¥77
BS-480E	4	80	8	8	5	7	50	¥76
BS-485E	4	85	8	8	5	7	50	¥79
BS-490E	4	90	8	8	5	7	50	¥82
BS-495E	4	95	8	8	5	7	50	¥86
BS-4100E	4	100	8	8	5	7	50	¥92
BS-4110E	4	110	8	8	5	7	50	¥100
BS-4120E	4	120	8	8	5	7	50	¥106
BS-4130E	4	130	8	8	5	7	50	¥110
BS-4140E	4	140	8	8	5	7	50	¥120
BS-4150E	4	150	8	8	5	7	50	¥130

六角サポーター(両オネジ)

HEXAGONAL SPACER (BOTH MALE SCREW)

ESB-300E~400E (BS)

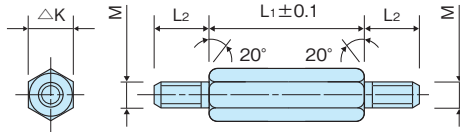

材質 ●快削黄銅 (C3604BD)
表面処理 ●ニッケルメッキ

Material ●Free-cutting brass (C3604BD)
Finish ●Nickel plating

※市販品につき、ケース単位(入数)でのご注文をお願い致します。

品番 Product No.	M	L ₁	L ₂	ΔK	入数 Lot	単価 Price
ESB-305E	3	5	6	5.5	50	¥31
ESB-306E	3	6	6	5.5	50	¥31
ESB-307E	3	7	6	5.5	50	¥32
ESB-308E	3	8	6	5.5	50	¥32
ESB-309E	3	9	6	5.5	50	¥33
ESB-310E	3	10	6	5.5	50	¥33
ESB-311E	3	11	6	5.5	50	¥38
ESB-312E	3	12	6	5.5	50	¥33
ESB-313E	3	13	6	5.5	50	¥43
ESB-314E	3	14	6	5.5	50	¥43
ESB-315E	3	15	6	5.5	50	¥33
ESB-318E	3	18	6	5.5	50	¥48
ESB-320E	3	20	6	5.5	50	¥48
ESB-325E	3	25	6	5.5	50	¥56
ESB-330E	3	30	6	5.5	50	¥56
ESB-335E	3	35	6	5.5	50	¥61
ESB-340E	3	40	6	5.5	50	¥61
ESB-345E	3	45	6	5.5	50	¥66
ESB-350E	3	50	6	5.5	50	¥66
ESB-355E	3	55	6	5.5	50	¥71
ESB-360E	3	60	6	5.5	50	¥71

品番 Product No.	M	L ₁	L ₂	ΔK	入数 Lot	単価 Price
ESB-408E	4	8	7	7	50	¥45
ESB-410E	4	10	7	7	50	¥46
ESB-412E	4	12	7	7	50	¥47
ESB-413E	4	13	7	7	50	¥49
ESB-414E	4	14	7	7	50	¥47
ESB-415E	4	15	7	7	50	¥49
ESB-417E	4	17	7	7	50	¥54
ESB-418E	4	18	7	7	50	¥64
ESB-420E	4	20	7	7	50	¥69
ESB-423E	4	23	7	7	50	¥74
ESB-425E	4	25	7	7	50	¥66
ESB-428E	4	28	7	7	50	¥66
ESB-430E	4	30	7	7	50	¥66
ESB-435E	4	35	7	7	50	¥66
ESB-440E	4	40	7	7	50	¥71
ESB-445E	4	45	7	7	50	¥71
ESB-450E	4	50	7	7	50	¥71
ESB-455E	4	55	7	7	50	¥76
ESB-460E	4	60	7	7	50	¥76

六角サポーター(ステンレス)(両オネジ)

HEXAGONAL SPACER (STAINLESS) (BOTH MALE SCREW)

ESU-300 (SUS)

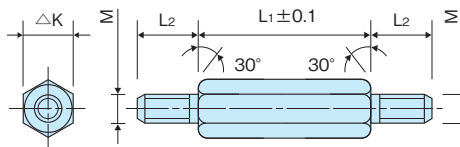

材質 ●快削ステンレス鋼 (SUS303)
表面処理 ●脱脂

Material ●Free-cutting stainless steel (SUS303)
Finish ●Degreasing

※市販品につき、ケース単位(入数)でのご注文をお願い致します。

品番 Product No.	M	L ₁	L ₂	ΔK	入数 Lot	単価 Price
ESU-305	3	5	6	5.5	50	¥76
ESU-306	3	6	6	5.5	50	¥76
ESU-307	3	7	6	5.5	50	¥76
ESU-308	3	8	6	5.5	50	¥78
ESU-309	3	9	6	5.5	50	¥78
ESU-310	3	10	6	5.5	50	¥78
ESU-311	3	11	6	5.5	50	¥80
ESU-312	3	12	6	5.5	50	¥80

品番 Product No.	M	L ₁	L ₂	ΔK	入数 Lot	単価 Price
ESU-313	3	13	6	5.5	50	¥80
ESU-314	3	14	6	5.5	50	¥80
ESU-315	3	15	6	5.5	50	¥80
ESU-318	3	18	6	5.5	50	¥82
ESU-320	3	20	6	5.5	50	¥82
ESU-325	3	25	6	5.5	50	¥85
ESU-330	3	30	6	5.5	50	¥91

丸サポーター(黄銅)

ROUND SPACER (BRASS)

BRB-300E~400E (BS)

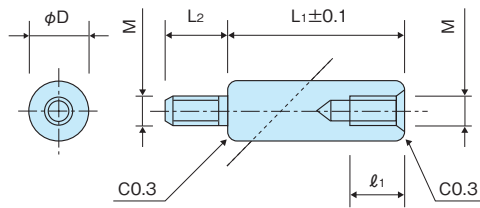

材質 ●快削黄銅(C3604BD)

表面处理 ●ニッケルメッキ

Material ●Free-cutting brass (C3604BD)

Finish ●Nickel plating

※市販品につき、ケース単位(入数)でのご注文をお願い致します。

品番 Product No.	M	L ₁	L ₂	ℓ ₁	φD	入数 Lot	単価 Price
BRB-304E	3	4	6	2.5	6	50	¥19
BRB-304.5E	3	4.5	6	2.5	6	50	¥19
BRB-305E	3	5	6	3.5	6	50	¥19
BRB-305.5E	3	5.5	6	3.5	6	50	¥19
BRB-306E	3	6	6	4	6	50	¥19
BRB-306.5E	3	6.5	6	4	6	50	¥19
BRB-307E	3	7	6	5	6	50	¥19
BRB-307.5E	3	7.5	6	5	6	50	¥19
BRB-308E	3	8	6	6	6	50	¥19
BRB-308.5E	3	8.5	6	6	6	50	¥20
BRB-309E	3	9	6	6	6	50	¥21
BRB-309.5E	3	9.5	6	6	6	50	¥22
BRB-310E	3	10	6	6	6	50	¥22
BRB-311E	3	11	6	6	6	50	¥22
BRB-312E	3	12	6	6	6	50	¥22
BRB-312.5E	3	12.5	6	6	6	50	¥22
BRB-313E	3	13	6	6	6	50	¥22
BRB-314E	3	14	6	6	6	50	¥22
BRB-315E	3	15	6	6	6	50	¥22
BRB-316E	3	16	6	6	6	50	¥23
BRB-316.5E	3	16.5	6	6	6	50	¥24
BRB-317E	3	17	6	6	6	50	¥24
BRB-317.5E	3	17.5	6	6	6	50	¥25
BRB-318E	3	18	6	6	6	50	¥25
BRB-319E	3	19	6	6	6	50	¥27
BRB-320E	3	20	6	6	6	50	¥27
BRB-321E	3	21	6	6	6	50	¥29
BRB-322E	3	22	6	6	6	50	¥30
BRB-323E	3	23	6	6	6	50	¥31
BRB-324E	3	24	6	6	6	50	¥32
BRB-325E	3	25	6	6	6	50	¥33
BRB-326E	3	26	6	6	6	50	¥34
BRB-327E	3	27	6	6	6	50	¥35
BRB-328E	3	28	6	6	6	50	¥36
BRB-329E	3	29	6	6	6	50	¥36
BRB-330E	3	30	6	6	6	50	¥36
BRB-335E	3	35	6	6	6	50	¥38
BRB-340E	3	40	6	6	6	50	¥41
BRB-345E	3	45	6	6	6	50	¥48
BRB-350E	3	50	6	6	6	50	¥53
BRB-355E	3	55	6	6	6	50	¥58
BRB-360E	3	60	6	6	6	50	¥63

品番 Product No.	M	L ₁	L ₂	ℓ ₁	φD	入数 Lot	単価 Price
BRB-406E	4	6	7	3.5	8	50	¥34
BRB-407E	4	7	7	4.5	8	50	¥35
BRB-408E	4	8	7	5.5	8	50	¥36
BRB-409E	4	9	7	6	8	50	¥36
BRB-410E	4	10	7	7	8	50	¥36
BRB-411E	4	11	7	8	8	50	¥38
BRB-412E	4	12	7	8	8	50	¥38
BRB-413E	4	13	7	8	8	50	¥39
BRB-414E	4	14	7	8	8	50	¥41
BRB-415E	4	15	7	8	8	50	¥41
BRB-416E	4	16	7	8	8	50	¥44
BRB-417E	4	17	7	8	8	50	¥46
BRB-418E	4	18	7	8	8	50	¥46
BRB-419E	4	19	7	8	8	50	¥47
BRB-420E	4	20	7	8	8	50	¥48
BRB-421E	4	21	7	8	8	50	¥49
BRB-422E	4	22	7	8	8	50	¥50
BRB-423E	4	23	7	8	8	50	¥54
BRB-424E	4	24	7	8	8	50	¥54
BRB-425E	4	25	7	8	8	50	¥54
BRB-426E	4	26	7	8	8	50	¥56
BRB-427E	4	27	7	8	8	50	¥58
BRB-428E	4	28	7	8	8	50	¥59
BRB-429E	4	29	7	8	8	50	¥60
BRB-430E	4	30	7	8	8	50	¥59
BRB-435E	4	35	7	8	8	50	¥63
BRB-440E	4	40	7	8	8	50	¥69
BRB-445E	4	45	7	8	8	50	¥73
BRB-450E	4	50	7	8	8	50	¥78
BRB-455E	4	55	7	8	8	50	¥83
BRB-460E	4	60	7	8	8	50	¥87

丸サポーター(黄銅)(スリ割付)

ROUND SPACER (BRASS) (SLOTTED)

BRB-300SE~400SE (BS)

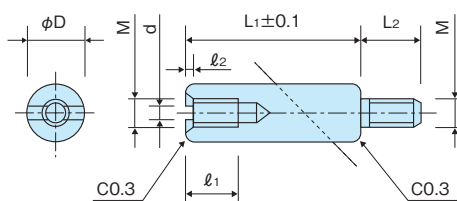

材 質 ●快削黄銅(C3604BD)

表面処理 ●ニッケルメッキ

Material ●Free-cutting brass(C3604BD)

Finish ●Nickel plating

※市販品につき、ケース単位(入数)でのご注文をお願い致します。

品番 Product No.	M	L ₁	L ₂	l ₁	l ₂	d	φD	入数 Lot	単価 Price
BRB-304SE	3	4	6	2.5	1.0	1.0	6	50	¥32
BRB-304.5SE	3	4.5	6	2.5	1.0	1.0	6	50	¥32
BRB-305SE	3	5	6	3.5	1.0	1.0	6	50	¥32
BRB-305.5SE	3	5.5	6	3.5	1.0	1.0	6	50	¥32
BRB-306SE	3	6	6	4	1.0	1.0	6	50	¥32
BRB-306.5SE	3	6.5	6	4	1.0	1.0	6	50	¥32
BRB-307SE	3	7	6	5	1.0	1.0	6	50	¥32
BRB-307.5SE	3	7.5	6	5	1.0	1.0	6	50	¥33
BRB-308SE	3	8	6	6	1.0	1.0	6	50	¥33
BRB-308.5SE	3	8.5	6	6	1.0	1.0	6	50	¥33
BRB-309SE	3	9	6	6	1.0	1.0	6	50	¥33
BRB-309.5SE	3	9.5	6	6	1.0	1.0	6	50	¥33
BRB-310SE	3	10	6	6	1.0	1.0	6	50	¥33
BRB-311SE	3	11	6	6	1.0	1.0	6	50	¥34
BRB-312SE	3	12	6	6	1.0	1.0	6	50	¥34
BRB-312.5SE	3	12.5	6	6	1.0	1.0	6	50	¥36
BRB-313SE	3	13	6	6	1.0	1.0	6	50	¥36
BRB-314SE	3	14	6	6	1.0	1.0	6	50	¥36
BRB-315SE	3	15	6	6	1.0	1.0	6	50	¥36
BRB-316SE	3	16	6	6	1.0	1.0	6	50	¥36
BRB-316.5SE	3	16.5	6	6	1.0	1.0	6	50	¥37
BRB-317SE	3	17	6	6	1.0	1.0	6	50	¥37
BRB-317.5SE	3	17.5	6	6	1.0	1.0	6	50	¥40
BRB-318SE	3	18	6	6	1.0	1.0	6	50	¥40
BRB-319SE	3	19	6	6	1.0	1.0	6	50	¥40
BRB-320SE	3	20	6	6	1.0	1.0	6	50	¥41
BRB-321SE	3	21	6	6	1.0	1.0	6	50	¥46
BRB-322SE	3	22	6	6	1.0	1.0	6	50	¥46
BRB-323SE	3	23	6	6	1.0	1.0	6	50	¥46
BRB-324SE	3	24	6	6	1.0	1.0	6	50	¥46
BRB-325SE	3	25	6	6	1.0	1.0	6	50	¥46
BRB-326SE	3	26	6	6	1.0	1.0	6	50	¥47
BRB-327SE	3	27	6	6	1.0	1.0	6	50	¥47
BRB-328SE	3	28	6	6	1.0	1.0	6	50	¥48
BRB-329SE	3	29	6	6	1.0	1.0	6	50	¥48
BRB-330SE	3	30	6	6	1.0	1.0	6	50	¥48
BRB-335SE	3	35	6	6	1.0	1.0	6	50	¥50
BRB-340SE	3	40	6	6	1.0	1.0	6	50	¥53
BRB-345SE	3	45	6	6	1.0	1.0	6	50	¥59
BRB-350SE	3	50	6	6	1.0	1.0	6	50	¥64
BRB-355SE	3	55	6	6	1.0	1.0	6	50	¥69
BRB-360SE	3	60	6	6	1.0	1.0	6	50	¥74

品番 Product No.	M	L ₁	L ₂	l ₁	l ₂	d	φD	入数 Lot	単価 Price
BRB-406SE	4	6	7	3.5	1.5	1.5	8	50	¥36
BRB-407SE	4	7	7	4.5	1.5	1.5	8	50	¥36
BRB-408SE	4	8	7	5.5	1.5	1.5	8	50	¥37
BRB-409SE	4	9	7	6	1.5	1.5	8	50	¥37
BRB-410SE	4	10	7	7	1.5	1.5	8	50	¥37
BRB-411SE	4	11	7	8	1.5	1.5	8	50	¥39
BRB-412SE	4	12	7	8	1.5	1.5	8	50	¥39
BRB-413SE	4	13	7	8	1.5	1.5	8	50	¥40
BRB-414SE	4	14	7	8	1.5	1.5	8	50	¥42
BRB-415SE	4	15	7	8	1.5	1.5	8	50	¥42
BRB-416SE	4	16	7	8	1.5	1.5	8	50	¥45
BRB-417SE	4	17	7	8	1.5	1.5	8	50	¥47
BRB-418SE	4	18	7	8	1.5	1.5	8	50	¥47
BRB-419SE	4	19	7	8	1.5	1.5	8	50	¥48
BRB-420SE	4	20	7	8	1.5	1.5	8	50	¥49
BRB-421SE	4	21	7	8	1.5	1.5	8	50	¥50
BRB-422SE	4	22	7	8	1.5	1.5	8	50	¥51
BRB-423SE	4	23	7	8	1.5	1.5	8	50	¥55
BRB-424SE	4	24	7	8	1.5	1.5	8	50	¥55
BRB-425SE	4	25	7	8	1.5	1.5	8	50	¥55
BRB-426SE	4	26	7	8	1.5	1.5	8	50	¥57
BRB-427SE	4	27	7	8	1.5	1.5	8	50	¥59
BRB-428SE	4	28	7	8	1.5	1.5	8	50	¥60
BRB-429SE	4	29	7	8	1.5	1.5	8	50	¥61
BRB-430SE	4	30	7	8	1.5	1.5	8	50	¥60
BRB-435SE	4	35	7	8	1.5	1.5	8	50	¥64
BRB-440SE	4	40	7	8	1.5	1.5	8	50	¥70
BRB-445SE	4	45	7	8	1.5	1.5	8	50	¥74
BRB-450SE	4	50	7	8	1.5	1.5	8	50	¥79
BRB-455SE	4	55	7	8	1.5	1.5	8	50	¥84
BRB-460SE	4	60	7	8	1.5	1.5	8	50	¥88

丸サポーター(ステンレス)

ROUND SPACER (STAINLESS)

BRU-300 (SUS)

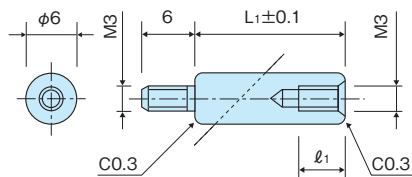

材質 ● 快削ステンレス鋼 (SUS303)

表面処理 ● 脱脂

Material ● Free-cutting stainless steel (SUS303)

Finish ● Degreasing

※市販品につき、ケース単位(入数)でのご注文をお願い致します。

品番 Product No.	L ₁	ℓ ₁	入数 Lot	単価 Price
BRU-304	4	2	50	¥51
BRU-304.5	4.5	2	50	¥51
BRU-305	5	3	50	¥45
BRU-305.5	5.5	3	50	¥45
BRU-306	6	4	50	¥48
BRU-306.5	6.5	4	50	¥48
BRU-307	7	5	50	¥51
BRU-307.5	7.5	5	50	¥51
BRU-308	8	6	50	¥51
BRU-308.5	8.5	6	50	¥51
BRU-309	9	6	50	¥53
BRU-309.5	9.5	6	50	¥53
BRU-310	10	6	50	¥54
BRU-311	11	6	50	¥56

品番 Product No.	L ₁	ℓ ₁	入数 Lot	単価 Price
BRU-312	12	6	50	¥58
BRU-312.5	12.5	6	50	¥58
BRU-313	13	6	50	¥67
BRU-314	14	6	50	¥67
BRU-315	15	6	50	¥69
BRU-316	16	6	50	¥71
BRU-316.5	16.5	6	50	¥71
BRU-317	17	6	50	¥71
BRU-317.5	17.5	6	50	¥71
BRU-318	18	6	50	¥71
BRU-319	19	6	50	¥73
BRU-320	20	6	50	¥74
BRU-321	21	6	50	¥75
BRU-322	22	6	50	¥76

品番 Product No.	L ₁	ℓ ₁	入数 Lot	単価 Price
BRU-323	23	6	50	¥76
BRU-324	24	6	50	¥77
BRU-325	25	6	50	¥78
BRU-326	26	6	50	¥80
BRU-327	27	6	50	¥82
BRU-328	28	6	50	¥84
BRU-329	29	6	50	¥86
BRU-330	30	6	50	¥87
BRU-335	35	6	50	¥95
BRU-340	40	6	50	¥100
BRU-345	45	6	50	¥109
BRU-350	50	6	50	¥111
BRU-355	55	6	50	¥117
BRU-360	60	6	50	¥133

丸サポーター(ステンレス)(スリ割付)

ROUND SPACER (STAINLESS) (SLOTTED)

BRU-300S (SUS)

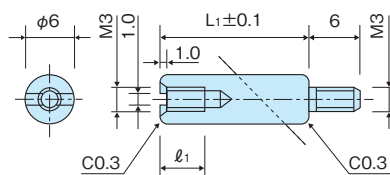

材質 ● 快削ステンレス鋼 (SUS303)

表面処理 ● 脱脂

Material ● Free-cutting stainless steel (SUS303)

Finish ● Degreasing

※市販品につき、ケース単位(入数)でのご注文をお願い致します。

品番 Product No.	L ₁	ℓ ₁	入数 Lot	単価 Price
BRU-304S	4	2	50	¥67
BRU-304.5S	4.5	2	50	¥67
BRU-305S	5	3	50	¥62
BRU-305.5S	5.5	3	50	¥62
BRU-306S	6	4	50	¥65
BRU-306.5S	6.5	4	50	¥65
BRU-307S	7	5	50	¥67
BRU-307.5S	7.5	5	50	¥67
BRU-308S	8	6	50	¥67
BRU-308.5S	8.5	6	50	¥67
BRU-309S	9	6	50	¥69
BRU-309.5S	9.5	6	50	¥69
BRU-310S	10	6	50	¥70
BRU-311S	11	6	50	¥73

品番 Product No.	L ₁	ℓ ₁	入数 Lot	単価 Price
BRU-312S	12	6	50	¥75
BRU-312.5S	12.5	6	50	¥75
BRU-313S	13	6	50	¥84
BRU-314S	14	6	50	¥84
BRU-315S	15	6	50	¥86
BRU-316S	16	6	50	¥88
BRU-316.5S	16.5	6	50	¥88
BRU-317S	17	6	50	¥88
BRU-317.5S	17.5	6	50	¥88
BRU-318S	18	6	50	¥88
BRU-319S	19	6	50	¥89
BRU-320S	20	6	50	¥90
BRU-321S	21	6	50	¥91
BRU-322S	22	6	50	¥92

品番 Product No.	L ₁	ℓ ₁	入数 Lot	単価 Price
BRU-323S	23	6	50	¥93
BRU-324S	24	6	50	¥94
BRU-325S	25	6	50	¥95
BRU-326S	26	6	50	¥97
BRU-327S	27	6	50	¥99
BRU-328S	28	6	50	¥100
BRU-329S	29	6	50	¥101
BRU-330S	30	6	50	¥103
BRU-335S	35	6	50	¥111
BRU-340S	40	6	50	¥117
BRU-345S	45	6	50	¥125
BRU-350S	50	6	50	¥128
BRU-355S	55	6	50	¥133
BRU-360S	60	6	50	¥150

丸サポーター (オールジュラコン)

ROUND SPACER (ALL-POLYACETAL)

BR-300A~400A (POM)

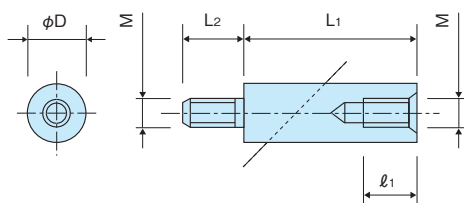

材 質 ●ジュラコン (POM)
色 ●乳白色
熱変形温度 ●1.82MPa...110°
UL規格 ●UL94-HB (材料)

Material ●Polyacetal (POM)
Color ●Milky-white
Heat deflection temperature ●1.82MPa...110°
UL standards ●UL94-HB (Material)

※市販品につき、ケース単位(入数)でのご注文をお願い致します。

品番 Product No.	M	L ₁	L ₂	φ ₁	φD	入数 Lot	単価 Price
BR-306A	3	6	6	4	6	50	¥51
BR-307A	3	7	6	5	6	50	¥56
BR-308A	3	8	6	6	6	50	¥56
BR-309A	3	9	6	6	6	50	¥56
BR-310A	3	10	6	6	6	50	¥56
BR-311A	3	11	6	6	6	50	¥61
BR-312A	3	12	6	6	6	50	¥61
BR-313A	3	13	6	6	6	50	¥61
BR-314A	3	14	6	6	6	50	¥61
BR-315A	3	15	6	6	6	50	¥61
BR-316A	3	16	6	6	6	50	¥61
BR-317A	3	17	6	6	6	50	¥61
BR-318A	3	18	6	6	6	50	¥61
BR-319A	3	19	6	6	6	50	¥66
BR-320A	3	20	6	6	6	50	¥66
BR-325A	3	25	6	6	6	50	¥66
BR-330A	3	30	6	6	6	50	¥71
BR-335A	3	35	6	6	6	50	¥81
BR-340A	3	40	6	6	6	50	¥86

品番 Product No.	M	L ₁	L ₂	φ ₁	φD	入数 Lot	単価 Price
BR-408A	4	8	8	5.5	8	50	¥61
BR-409A	4	9	8	6	8	50	¥61
BR-410A	4	10	8	7	8	50	¥61
BR-411A	4	11	8	8	8	50	¥66
BR-412A	4	12	8	8	8	50	¥66
BR-413A	4	13	8	8	8	50	¥66
BR-414A	4	14	8	8	8	50	¥66
BR-415A	4	15	8	8	8	50	¥66
BR-416A	4	16	8	8	8	50	¥66
BR-417A	4	17	8	8	8	50	¥66
BR-418A	4	18	8	8	8	50	¥66
BR-419A	4	19	8	8	8	50	¥71
BR-420A	4	20	8	8	8	50	¥71
BR-421A	4	21	8	8	8	50	¥71
BR-422A	4	22	8	8	8	50	¥71
BR-423A	4	23	8	8	8	50	¥76
BR-424A	4	24	8	8	8	50	¥76
BR-425A	4	25	8	8	8	50	¥81
BR-426A	4	26	8	8	8	50	¥81
BR-427A	4	27	8	8	8	50	¥81
BR-428A	4	28	8	8	8	50	¥86
BR-429A	4	29	8	8	8	50	¥86
BR-430A	4	30	8	8	8	50	¥91
BR-435A	4	35	8	8	8	50	¥96
BR-440A	4	40	8	8	8	50	¥101
BR-445A	4	45	8	8	8	50	¥106
BR-450A	4	50	8	8	8	50	¥111

ローレットビス

KNURLED KNOBS

NB-300A~500A (BS)

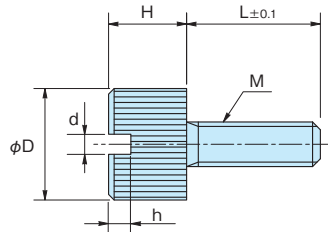

材 質 ●快削黄銅 (C3604BD)

表面処理 ●ニッケルメッキ

Material ●Free-cutting brass (C3604BD)

Finish ●Nickel plating

※市販品につき、ケース単位(入数)でのご注文をお願い致します。

品番 Product No.	D	H	L	d	h	M	入数 Lot	単価 Price						
NB-306AA	6	3	6	1.5	1.5	3	50	¥41						
NB-308AA			8					¥44						
NB-310AA			10					¥46						
NB-312AA			12					¥48						
NB-315AA			15					¥50						
NB-318AA			18					¥52						
NB-320AA			20					¥54						
NB-325AA			25					¥57						
NB-306GA			8					3	6	1.5	1.5	3	50	¥49
NB-308GA									8					¥51
NB-310GA	10	¥53												
NB-312GA	12	¥55												
NB-315GA	15	¥57												
NB-318GA	18	¥61												
NB-320GA	20	¥66												
NB-325GA	25	¥71												
NB-306BA	6	6		6	1.5	1.5	3		50					¥46
NB-308BA				8										¥48
NB-310BA			10	¥50										
NB-312BA			12	¥52										
NB-315BA			15	¥53										
NB-318BA			18	¥55										
NB-320BA			20	¥56										
NB-306IA			8	6				6		1.5	1.5	3	50	¥55
NB-308IA								8						¥57
NB-310IA								10						¥60
NB-312IA	12	¥62												
NB-315IA	15	¥65												
NB-318IA	18	¥67												
NB-320IA	20	¥69												
NB-306CA	6	8			6	1.5	1.5	3	50					¥49
NB-308CA					8									¥52
NB-310CA					10									¥55
NB-312CA			12	¥53										
NB-315CA			15	¥55										
NB-318CA			18	¥56										
NB-320CA			20	¥58										
NB-306KA			8	8	6					1.5	1.5	3	50	¥57
NB-308KA					8									¥59
NB-310KA					10									¥61
NB-312KA	12	¥63												
NB-315KA	15	¥66												
NB-318KA	18	¥69												
NB-320KA	20	¥72												
NB-306DA	6	10			6	1.5	1.5	3	50					¥50
NB-308DA					8									¥52
NB-310DA					10									¥54

品番 Product No.	D	H	L	d	h	M	入数 Lot	単価 Price
NB-312DA	6	10	12	1.5	1.5	3	50	¥54
NB-315DA			15					¥56
NB-318DA			18					¥58
NB-320DA			20					¥59
NB-306LA	8	10	6	1.5	1.5	3	50	¥60
NB-308LA			8					¥62
NB-310LA			10					¥64
NB-312LA			12					¥66
NB-315LA	6	12	15	1.5	1.5	3	50	¥69
NB-318LA			18					¥71
NB-320LA			20					¥74
NB-306EA			8					12
NB-308EA	8	¥53						
NB-310EA	10	¥54						
NB-312EA	12	¥56						
NB-315EA	6	15	15	1.5	1.5	3	50	¥58
NB-318EA			18					¥59
NB-320EA			20					¥61
NB-306MA			8					15
NB-308MA	8	¥64						
NB-310MA	10	¥66						
NB-312MA	12	¥68						
NB-315MA	6	18	15	1.5	1.5	3	50	¥71
NB-318MA			18					¥74
NB-320MA			20					¥76
NB-306FA			8					18
NB-308FA	8	¥55						
NB-310FA	10	¥56						
NB-312FA	12	¥58						
NB-315FA	6	20	15	1.5	1.5	3	50	¥60
NB-318FA			18					¥61
NB-320FA			20					¥63
NB-306NA			8					20
NB-308NA	8	¥67						
NB-310NA	10	¥69						
NB-312NA	12	¥72						
NB-315NA	6	25	15	1.5	1.5	3	50	¥74
NB-318NA			18					¥77
NB-320NA			20					¥79
NB-406HA			8					4
NB-408HA	8	¥55						
NB-410HA	10	¥58						
NB-412HA	12	¥60						
NB-415HA	6	30	15	1.8	2	4	50	¥63
NB-418HA			18					¥67
NB-420HA			20					¥71
NB-425HA	8	30	25	1.8	2	4	50	¥75
NB-430HA			30					¥79

品番 Product No.	D	H	L	d	h	M	入数 Lot	単価 Price						
NB-4060A	10	4	6	1.8	2	4	50	¥61						
NB-4080A			8					¥65						
NB-4100A			10					¥69						
NB-4120A			12					¥72						
NB-4150A			15					¥76						
NB-4180A			18					¥82						
NB-4200A			20					¥88						
NB-4250A			25					¥94						
NB-4300A			30					¥99						
NB-408KA			8					8	8	1.8	2	4	50	¥61
NB-410KA	10	¥63												
NB-412KA	12	¥66												
NB-415KA	15	¥68												
NB-418KA	18	¥72												
NB-420KA	20	¥75												
NB-425KA	25	¥79												
NB-408QA	10	8		8	1.8	2	4		50					¥72
NB-410QA				10										¥75
NB-412QA				12										¥79
NB-415QA			15	¥83										
NB-418QA			18	¥88										
NB-420QA			20	¥93										
NB-425QA			25	¥99										
NB-408LA			8	10				8		1.8	2	4	50	¥63
NB-410LA								10						¥65
NB-412LA								12						¥68
NB-415LA	15	¥70												
NB-418LA	18	¥74												
NB-420LA	20	¥77												
NB-425LA	25	¥81												
NB-408RA	10	10			8	1.8	2	4	50					¥75
NB-410RA					10									¥79
NB-412RA					12									¥82
NB-415RA			15	¥86										
NB-418RA			18	¥91										
NB-420RA			20	¥97										
NB-425RA			25	¥102										
NB-408MA			8	12	8					1.8	2	4	50	¥65
NB-410MA					10									¥68
NB-412MA					12									¥70
NB-415MA	15	¥73												
NB-418MA	18	¥76												
NB-420MA	20	¥80												
NB-425MA	25	¥83												
NB-408SA	10	12			8	1.8	2	4	50					¥78
NB-410SA					10									¥82
NB-412SA					12									¥86
NB-415SA			15	¥89										
NB-418SA			18	¥95										
NB-420SA			20	¥100										
NB-425SA			25	¥105										
NB-408NA			8	15	8					1.8	2	4	50	¥69
NB-410NA					10									¥71
NB-412NA					12									¥73
NB-415NA	15	¥76												
NB-418NA	18	¥79												
NB-420NA	20	¥83												
NB-425NA	25	¥86												
NB-408TA	10	15			8	1.8	2	4	50					¥83
NB-410TA					10									¥87
NB-412TA					12									¥91
NB-415TA			15	¥94										
NB-418TA			18	¥100										

品番 Product No.	D	H	L	d	h	M	入数 Lot	単価 Price						
NB-420TA	10	15	20	1.8	2	4	50	¥105						
NB-425TA			25					¥110						
NB-5060A	10	4	6	1.8	2	4	50	¥64						
NB-5080A			8					¥68						
NB-5100A			10					¥71						
NB-5120A			12					¥75						
NB-5150A			15					¥78						
NB-5180A			18					¥84						
NB-5200A			20					¥90						
NB-5250A			25					¥96						
NB-5300A			30					¥102						
NB-506UA			12					4	6	2	2	5	50	¥73
NB-508UA	8	¥78												
NB-510UA	10	¥83												
NB-512UA	12	¥89												
NB-515UA	15	¥93												
NB-518UA	18	¥102												
NB-520UA	20	¥110												
NB-525UA	25	¥119												
NB-530UA	30	¥127												
NB-510RA	10	10		10	2	2	5		50					¥81
NB-512RA			12	¥85										
NB-515RA			15	¥89										
NB-518RA			18	¥93										
NB-520RA			20	¥99										
NB-525RA			25	¥106										
NB-530RA			30	¥112										
NB-510WA			12	10				10		2	2	5	50	¥96
NB-512WA								12						¥102
NB-515WA								15						¥108
NB-518WA	18	¥114												
NB-520WA	20	¥123												
NB-525WA	25	¥132												
NB-530WA	30	¥141												
NB-510SA	10	12			10	2	2	5	50					¥84
NB-512SA					12									¥88
NB-515SA					15									¥91
NB-518SA			18	¥95										
NB-520SA			20	¥102										
NB-525SA			25	¥108										
NB-530SA			30	¥115										
NB-510XA			12	12	10					2	2	5	50	¥101
NB-512XA					12									¥106
NB-515XA					15									¥111
NB-518XA	18	¥117												
NB-520XA	20	¥126												
NB-525XA	25	¥136												
NB-530XA	30	¥145												
NB-510TA	10	15			10	2	2	5	50					¥89
NB-512TA					12									¥93
NB-515TA					15									¥98
NB-518TA			18	¥102										
NB-520TA			20	¥108										
NB-525TA			25	¥114										
NB-530TA			30	¥121										
NB-510YA			12	15	10					2	2	5	50	¥108
NB-512YA					12									¥114
NB-515YA					15									¥120
NB-518YA	18	¥126												
NB-520YA	20	¥135												
NB-525YA	25	¥144												
NB-530YA	30	¥153												

ローレットビス

KNURLED KNOBS

NB-300B~500B (BS)

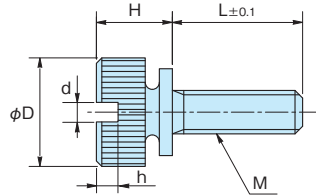

材 質 ●快削黄銅 (C3604BD)

表面処理 ●ニッケルメッキ

Material ●Free-cutting brass (C3604BD)

Finish ●Nickel plating

※市販品につき、ケース単位(入数)でのご注文をお願い致します。

品番 Product No.	φD	H	L	d	h	M	入数 Lot	単価 Price					
NB-306BB	6	7	6	1.5	1.5	3	50	¥46					
NB-308BB			8					¥48					
NB-310BB			10					¥49					
NB-312BB			12					¥51					
NB-315BB			15					¥53					
NB-318BB			18					¥55					
NB-320BB			20					¥57					
NB-325BB			25					¥59					
NB-306IB			8					8	6	1.8	2	4	¥54
NB-308IB									8				¥57
NB-310IB	10	¥59											
NB-312IB	12	¥61											
NB-315IB	15	¥64											
NB-318IB	18	¥67											
NB-320IB	20	¥71											
NB-325IB	25	¥75											
NB-406JB	10	10		6	1.8	2	4		¥57				
NB-408JB				8					¥59				
NB-410JB			10	¥62									
NB-412JB			12	¥64									
NB-415JB			15	¥66									
NB-418JB			18	¥70									
NB-420JB			20	¥74									
NB-425JB			25	¥79									
NB-430JB			30	¥82									
NB-406PB			10	10				6	1.8	2	4	¥67	
NB-408PB	8	¥69											
NB-410PB	10	¥73											
NB-412PB	12	¥77											
NB-415PB	15	¥80											
NB-418PB	18	¥86											
NB-420PB	20	¥92											
NB-425PB	25	¥98											
NB-430PB	30	¥104											

品番 Product No.	φD	H	L	d	h	M	入数 Lot	単価 Price
NB-506QB	10	9	6	2	2	5	50	¥71
NB-508QB			8					¥75
NB-510QB			10					¥78
NB-512QB			12					¥82
NB-515QB			15					¥85
NB-518QB			18					¥91
NB-520QB			20					¥97
NB-525QB			25					¥103
NB-530QB			30					¥108
NB-506VB			12					12
NB-508VB	8	¥90						
NB-510VB	10	¥94						
NB-512VB	12	¥98						
NB-515VB	15	¥103						
NB-518VB	18	¥111						
NB-520VB	20	¥119						
NB-525VB	25	¥128						
NB-530VB	30	¥136						

ローレットビス

KNURLED KNOBS

NB-300E~500E (BS)

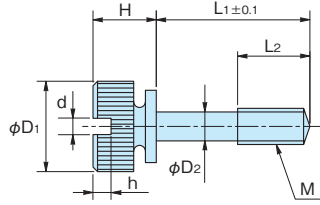

材 質 ●快削黄銅 (C3604BD)
表面処理 ●ニッケルメッキ

Material ●Free-cutting brass (C3604BD)
Finish ●Nickel plating

※市販品につき、ケース単位(入数)でのご注文をお願い致します。

品番 Product No.	φD ₁	φD ₂	H	L ₁	L ₂	d	h	M	入数 Lot	単価 Price
NB-310BE	6	2.2	7	10	6	1.5	1.5	3	50	¥49
NB-312BE				12						¥51
NB-315BE				15						¥53
NB-318BE				18						¥55
NB-320BE				20						¥57
NB-325BE				25						¥60
NB-330BE				30						¥63
NB-310IE	8	2.2	7	10	6	1.5	1.5	3	50	¥59
NB-312IE				12						¥61
NB-315IE				15						¥64
NB-318IE				18						¥67
NB-320IE				20						¥71
NB-325IE				25						¥75
NB-330IE				30						¥80
NB-412JE	8	3	8	12	8	1.8	1.8	4	50	¥63
NB-415JE				15						¥66
NB-418JE				18						¥69
NB-420JE				20						¥72
NB-425JE				25						¥77
NB-430JE				30						¥82
NB-435JE				35						¥87
NB-412PE	10	3	8	12	8	1.8	1.8	4	50	¥81
NB-415PE				15						¥90
NB-418PE				18						¥98
NB-420PE				20						¥108
NB-425PE				25						¥123
NB-430PE				30						¥138
NB-435PE				35						¥153

品番 Product No.	φD ₁	φD ₂	H	L ₁	L ₂	d	h	M	入数 Lot	単価 Price
NB-515QE	10	4	9	15	10	2	2	5	50	¥93
NB-518QE				18						¥105
NB-520QE				20						¥117
NB-525QE				25						¥128
NB-530QE				30						¥142
NB-535QE				35						¥157
NB-540QE				40						¥171
NB-515VE	12	4	9	15	10	2	2	5	50	¥128
NB-518VE				18						¥144
NB-520VE				20						¥160
NB-525VE				25						¥176
NB-530VE				30						¥197
NB-535VE				35						¥218
NB-540VE				40						¥239

ローレットビス

KNURLED KNOBS

NB-300C~500C (BS)

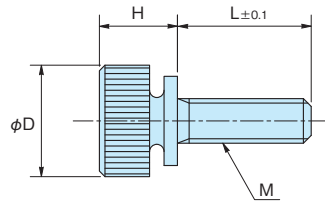

材質 ●快削黄銅 (C3604BD)

表面処理 ●ニッケルメッキ

Material ●Free-cutting brass (C3604BD)

Finish ●Nickel plating

※市販品につき、ケース単位(入数)でのご注文をお願い致します。

品番 Product No.	φD	H	L	M	入数 Lot	単価 Price				
NB-306BC	6	7	6	3	50	¥30				
NB-308BC			8			¥32				
NB-310BC			10			¥33				
NB-312BC			12			¥35				
NB-315BC			15			¥36				
NB-318BC			18			¥39				
NB-320BC			20			¥41				
NB-325BC			25			¥43				
NB-306JC			8			8	6	4	50	¥38
NB-308JC							8			¥41
NB-310JC	10	¥43								
NB-312JC	12	¥45								
NB-315JC	15	¥48								
NB-318JC	18	¥41								
NB-320JC	20	¥55								
NB-325JC	25	¥58								
NB-406JC	10	8		6	4		50			¥41
NB-408JC				8						¥43
NB-410JC			10	¥45						
NB-412JC			12	¥48						
NB-415JC			15	¥50						
NB-418JC			18	¥54						
NB-420JC			20	¥58						
NB-425JC			25	¥62						
NB-430JC			30	¥66						
NB-406PC			10	8		6		4	50	¥51
NB-408PC	8	¥53								
NB-410PC	10	¥56								
NB-412PC	12	¥60								
NB-415PC	15	¥64								
NB-418PC	18	¥70								
NB-420PC	20	¥76								
NB-425PC	25	¥82								
NB-430PC	30	¥88								

品番 Product No.	φD	H	L	M	入数 Lot	単価 Price
NB-506QC	10	9	6	5	50	¥54
NB-508QC			8			¥57
NB-510QC			10			¥61
NB-512QC			12			¥64
NB-515QC			15			¥68
NB-518QC			18			¥74
NB-520QC			20			¥79
NB-525QC			25			¥85
NB-530QC			30			¥91
NB-506VC			12			9
NB-508VC	8	¥70				
NB-510VC	10	¥75				
NB-512VC	12	¥80				
NB-515VC	15	¥85				
NB-518VC	18	¥94				
NB-520VC	20	¥102				
NB-525VC	25	¥110				
NB-530VC	30	¥118				

ローレットビス

KNURLED KNOBS

NB-300D~500D (BS)

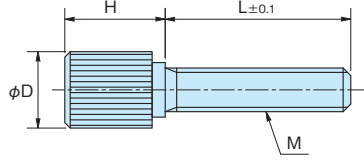

材 質 ●快削黄銅 (C3604BD)

表面処理 ●ニッケルメッキ

Material ●Free-cutting brass (C3604BD)

Finish ●Nickel plating

※市販品につき、ケース単位(入数)でのご注文をお願い致します。

品番 Product No.	φD	H	L	M	入数 Lot	単価 Price	品番 Product No.	φD	H	L	M	入数 Lot	単価 Price	品番 Product No.	φD	H	L	M	入数 Lot	単価 Price																		
NB-306BD	6	6	6	3	50	¥31	NB-306MD	8	8	6	3	50	¥46	NB-408SD	10	8	8	4	50	¥62																		
NB-308BD			8			¥32	NB-308MD			8			¥48	NB-410SD			10			¥64																		
NB-310BD			10			¥34	NB-310MD			10			¥50	NB-412SD			12			¥66																		
NB-312BD			12			¥35	NB-312MD			12			¥52	NB-415SD			15			¥73																		
NB-315BD			15			¥37	NB-315MD			15			¥55	NB-418SD			18			¥78																		
NB-318BD			18			¥39	NB-318MD			18			¥57	NB-420SD			20			¥84																		
NB-320BD		20	¥40			NB-320MD	20		¥60	NB-425SD			25	¥89																								
NB-306CD		8	6			6	3		50	¥32			NB-306ND	10		8	6			4	50	¥48	NB-408TD	12	8	8	5	50	¥67									
NB-308CD						8				¥34			NB-308ND				8					¥51	NB-410TD			10			¥71									
NB-310CD						10				¥35			NB-310ND				10					¥53	NB-412TD			12			¥74									
NB-312CD						12				¥37			NB-312ND				12					¥55	NB-415TD			15			¥78									
NB-315CD						15				¥38			NB-315ND				15					¥58	NB-418TD			18			¥83									
NB-318CD						18				¥40			NB-318ND				18					¥61	NB-420TD			20			¥89									
NB-320CD			20			¥42				NB-320ND			20			¥63	NB-425TD					25	¥94															
NB-306DD			10			6				6			3			50	¥35					NB-408KD	12		8	8			4	50	¥45	NB-510RD	15	10	10	5	50	¥63
NB-308DD										8							¥36					NB-410KD				10					¥47	NB-512RD			12			¥67
NB-310DD										10							¥37					NB-412KD				12					¥50	NB-515RD			15			¥71
NB-312DD										12							¥38					NB-415KD				15					¥52	NB-518RD			18			¥76
NB-315DD	15			¥40	NB-418KD			18		¥55	NB-520RD	20			¥82																							
NB-318DD	18			¥42	NB-420KD			20		¥59	NB-525RD	25			¥88																							
NB-320DD	20			¥43	NB-425KD	25		¥62		NB-530RD	30	¥95																										
NB-306ED	12			6	6	3		50		¥36	NB-408LD	15			8		8	4	50			¥47			NB-510SD	18					10	10		5	50			¥66
NB-308ED					8					¥37	NB-410LD						10					¥50			NB-512SD							12						¥70
NB-310ED					10					¥38	NB-412LD						12					¥52			NB-515SD							15						¥74
NB-312ED					12					¥40	NB-415LD						15					¥54			NB-518SD							18						¥78
NB-315ED		15			¥41		NB-418LD		18	¥57	NB-520SD			20			¥84																					
NB-318ED		18			¥43		NB-420LD		20	¥61	NB-525SD			25			¥91																					
NB-320ED		20		¥45	NB-425LD		25		¥64	NB-530SD	30			¥97																								
NB-306FD		15		6	6		3		50	¥38	NB-408MD			18	8		8			4	50	¥49		NB-510TD	20		10	10			5	50						¥71
NB-308FD					8					¥39	NB-410MD						10					¥52		NB-512TD				12										¥76
NB-310FD					10					¥41	NB-412MD						12					¥54		NB-515TD				15										¥80
NB-312FD					12					¥42	NB-415MD						15					¥57		NB-518TD				18										¥84
NB-315FD			15		¥43					NB-418MD	18		¥60			NB-520TD	20					¥91																
NB-318FD			18		¥45					NB-420MD	20		¥63			NB-525TD	25					¥97																
NB-320FD			20	¥47	NB-425MD					25	¥67		NB-530TD		30	¥103																						
NB-306ID			8	6	6					3	50		¥39		NB-408ND	10	8					8	4	50			¥53	NB-510WD	12	10			10			5	50	¥79
NB-308ID					8								¥41		NB-410ND							10					¥55	NB-512WD					12					¥84
NB-310ID					10								¥43		NB-412ND							12					¥57	NB-515WD					15					¥90
NB-312ID					12								¥46		NB-415ND							15					¥60	NB-518WD					18					¥96
NB-315ID	15				¥48	NB-418ND		18				¥63	NB-520WD		20			¥105																				
NB-318ID	18				¥51	NB-420ND		20				¥66	NB-525WD		25			¥114																				
NB-320ID	20			¥53	NB-425ND	25		¥70				NB-530WD	30		¥123																							
NB-306KD	10			6	6	3		50				¥41	NB-408QD		12		8	8	4			50				¥55	NB-510XD	15		10			10	5	50			¥83
NB-308KD					8							¥43	NB-410QD					10								¥57	NB-512XD						12					¥89
NB-310KD					10							¥46	NB-412QD					12								¥60	NB-515XD						15					¥94
NB-312KD					12							¥47	NB-415QD					15								¥67	NB-518XD						18					¥99
NB-315KD		15			¥50		NB-418QD		18			¥72	NB-520XD	20				¥109																				
NB-318KD		18			¥53		NB-420QD		20			¥77	NB-525XD	25				¥118																				
NB-320KD		20		¥56	NB-425QD		25		¥83			NB-530XD	30	¥127																								
NB-306LD		8		6	6		3		50			¥44	NB-408RD	10			8	8		4	50				¥59	NB-510YD	12			10	10	5	50					¥90
NB-308LD					8							¥46	NB-410RD					10							¥63	NB-512YD					12							¥96
NB-310LD					10							¥48	NB-412RD					12							¥66	NB-515YD					15							¥103
NB-312LD					12							¥50	NB-415RD					15							¥70	NB-518YD					18							¥109
NB-315LD			15		¥52					NB-418RD	18	¥75	NB-520YD			20		¥118																				
NB-318LD			18		¥55					NB-420RD	20	¥80	NB-525YD			25		¥127																				
NB-320LD			20	¥58	NB-425RD					25	¥86	NB-530YD	30			¥136																						

ローレットビス

KNURLED KNOBS

NB-300F~500F (BS)

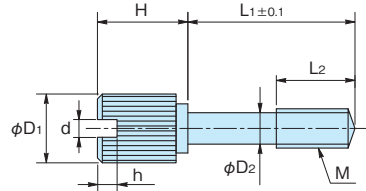

材 質 ●快削黄銅 (C3604BD)

表面処理 ●ニッケルメッキ

Material ●Free-cutting brass (C3604BD)

Finish ●Nickel plating

※市販品につき、ケース単位(入数)でのご注文をお願い致します。

品番 Product No.	φD ₁	φD ₂	H	L ₁	L ₂	d	h	M	入数 Lot	単価 Price
NB-310BF	2.2	6	6	10	6	1.5	1.5	3	50	¥48
NB-312BF				12						¥50
NB-315BF				15						¥51
NB-318BF				18						¥53
NB-320BF				20						¥55
NB-325BF				25						¥57
NB-330BF				30						¥59
NB-310CF	2.2	8	8	10	6	1.5	1.5	3	50	¥49
NB-312CF				12						¥51
NB-315CF				15						¥52
NB-318CF				18						¥54
NB-320CF				20						¥56
NB-325CF				25						¥58
NB-330CF				30						¥60
NB-310DF	6	2.2	10	10	6	1.5	1.5	3	50	¥51
NB-312DF				12						¥52
NB-315DF				15						¥53
NB-318DF				18						¥55
NB-320DF				20						¥57
NB-325DF				25						¥59
NB-330DF				30						¥60
NB-310EF	2.2	12	12	10	6	1.5	1.5	3	50	¥51
NB-312EF				12						¥53
NB-315EF				15						¥54
NB-318EF				18						¥55
NB-320EF				20						¥57
NB-325EF				25						¥59
NB-330EF				30						¥61
NB-310FF	2.2	15	15	10	6	1.5	1.5	3	50	¥52
NB-312FF				12						¥54
NB-315FF				15						¥55
NB-318FF				18						¥56
NB-320FF				20						¥58
NB-325FF				25						¥60
NB-330FF				30						¥62

品番 Product No.	φD ₁	φD ₂	H	L ₁	L ₂	d	h	M	入数 Lot	単価 Price
NB-310IF	2.2	6	6	10	6	1.5	1.5	3	50	¥60
NB-312IF				12						¥60
NB-315IF				15						¥55
NB-318IF				18						¥63
NB-320IF				20						¥64
NB-325IF				25						¥66
NB-330IF				30						¥68
NB-310KF	2.2	8	8	10	6	1.5	1.5	3	50	¥61
NB-312KF				12						¥62
NB-315KF				15						¥64
NB-318KF				18						¥65
NB-320KF				20						¥67
NB-325KF				25						¥69
NB-330KF				30						¥70
NB-310LF	8	2.2	10	10	6	1.5	1.5	3	50	¥63
NB-312LF				12						¥65
NB-315LF				15						¥66
NB-318LF				18						¥67
NB-320LF				20						¥69
NB-325LF				25						¥71
NB-330LF				30						¥73
NB-310MF	2.2	12	12	10	6	1.5	1.5	3	50	¥66
NB-312MF				12						¥67
NB-315MF				15						¥68
NB-318MF				18						¥70
NB-320MF				20						¥71
NB-325MF				25						¥73
NB-330MF				30						¥75
NB-310NF	2.2	15	15	10	6	1.5	1.5	3	50	¥69
NB-312NF				12						¥71
NB-315NF				15						¥72
NB-318NF				18						¥73
NB-320NF				20						¥75
NB-325NF				25						¥77
NB-330NF				30						¥78

品番 Product No.	φD ₁	φD ₂	H	L ₁	L ₂	d	h	M	入数 Lot	単価 Price	
NB-412KF	8	3	8	12	8	1.8	2	4	50	¥64	
NB-415KF				15						¥65	
NB-418KF				18						¥67	
NB-420KF				20						¥69	
NB-425KF				25						¥71	
NB-430KF				30						¥73	
NB-412LF		3	10	10	12	8	1.8	2	4	50	¥66
NB-415LF					15						¥68
NB-418LF					18						¥70
NB-420LF					20						¥72
NB-425LF					25						¥73
NB-430LF					30						¥75
NB-412MF		3	12	12	12	8	1.8	2	4	50	¥68
NB-415MF					15						¥70
NB-418MF					18						¥72
NB-420MF					20						¥74
NB-425MF					25						¥75
NB-430MF					30						¥77
NB-412NF		3	15	15	12	8	1.8	2	4	50	¥71
NB-415NF					15						¥73
NB-418NF					18						¥75
NB-420NF					20						¥77
NB-425NF					25						¥79
NB-430NF					30						¥80
NB-412QF		10	3	8	12	8	1.8	2	4	50	¥77
NB-415QF					15						¥78
NB-418QF					18						¥80
NB-420QF					20						¥82
NB-425QF					25						¥84
NB-430QF					30						¥86
NB-412RF	3		10	10	12	8	1.8	2	4	50	¥80
NB-415RF					15						¥82
NB-418RF					18						¥84
NB-420RF					20						¥85
NB-425RF					25						¥87
NB-430RF					30						¥89
NB-412SF	3		12	12	12	8	1.8	2	4	50	¥83
NB-415SF					15						¥85
NB-418SF					18						¥87
NB-420SF					20						¥88
NB-425SF					25						¥90
NB-430SF					30						¥92
NB-412TF	3		15	15	12	8	1.8	2	4	50	¥88
NB-415TF					15						¥90
NB-418TF					18						¥91
NB-420TF					20						¥93
NB-425TF					25						¥95
NB-430TF					30						¥97
NB-515RF	10		4	10	15	10	2	2	5	50	¥64
NB-518RF					18						¥77
NB-520RF					20						¥91
NB-525RF					25						¥104
NB-530RF					30						¥112
NB-535RF					35						¥120
NB-540RF		40	¥128								
NB-515SF		4	12	12	15	10	2	2	5	50	¥92
NB-518SF					18						¥97
NB-520SF					20						¥103
NB-525SF					25						¥108
NB-530SF					30						¥115
NB-535SF					35						¥123
NB-540SF		40	¥130								

品番 Product No.	φD ₁	φD ₂	H	L ₁	L ₂	d	h	M	入数 Lot	単価 Price								
NB-515TF	10	4	15	15	10	2	2	5	50	¥97								
NB-518TF				18						¥102								
NB-520TF				20						¥107								
NB-525TF				25						¥112								
NB-530TF				30						¥119								
NB-535TF				35						¥124								
NB-540TF				40						¥134								
NB-515WF				4						10	10	15	10	2	2	5	50	¥107
NB-518WF												18						¥115
NB-520WF												20						¥122
NB-525WF	25	¥130																
NB-530WF	30	¥141																
NB-535WF	35	¥152																
NB-540WF	40	¥163																
NB-515XF	12	4	12	15	10	2	2	5	50	¥112								
NB-518XF				18						¥119								
NB-520XF				20						¥127								
NB-525XF				25						¥134								
NB-530XF				30						¥145								
NB-535XF				35						¥155								
NB-540XF		40	¥166															
NB-515YF		4	15	15	15	10	2	2	5	50	¥119							
NB-518YF					18						¥126							
NB-520YF					20						¥134							
NB-525YF	25				¥141													
NB-530YF	30	¥152																
NB-535YF	35	¥164																
NB-540YF	40	¥175																

会社概要 COMPANY PROFILE

1個からの少ロット対応のみならず、
海外工場との連携と先進の設備・技術で「大量・多品種・短納期」を実現。
常に次世代に向けたクォリティでサポートします。

Quick delivery and large variety,
small-lot by advanced equipment and technology cooperation with overseas factories.
We always support by high quality for the next generation.

Planning



企画 Planning



設計 design



開発 development

Manufacturing



製造・生産(鑄造)
Manufacturing and production(casting)



製造・生産(NC系統)
Manufacturing and production(CNC system)



製造・生産(プレス加工)
Manufacturing and production(press processing)

Logistics



検査 Inspection



梱包 Packing



出荷 Product release (shipment)

本社・工場 Head office・Plant

株式会社ホシモト

〒544-0032 大阪府大阪市生野区中川西2丁目24番32号
TEL (06) 6741-4723 FAX (06) 6712-2609

HOSHIMOTO CO.,LTD.

2-24-32, NAKAGAWANISHI IKUNO-KU, OSAKA
TEL (06) 6741-4723 FAX (06) 6712-2609



韓国工場 KOREA

STAR21 CO.,LTD.

韓国釜山市江西区新湖洞208-23
TEL (051) 831-4315 FAX (051) 831-4319

STAR21 CO.,LTD.

208-23, SINHO-DONG, GANGSEO-GU, BUSAN KOREA
TEL (051) 831-4315 FAX (051) 831-4319



中国上海工場 Shanghai CHINA

星本機電配件(上海)有限公司

中国上海市奉賢区郵橋鎮叶張路89号
TEL (021) 5740-7335 FAX (021) 5740-7337

HOSHIMOTO(SHANGHAI) CO.,LTD.

NO.89 YEZHANG ROAD, WUQIAO FENGXIAN SHANGHAI
TEL (021) 5740-7335 FAX (021) 5740-7337



オーダーメイド MADE TO ORDER PRODUCTS

別作オーダー品も、設計・製造・配送まで
一貫したクオリティでお届けします。

We will also provide made-to-order products from design and production to delivery by the consistent quality.



NC複合旋盤加工品 / マシニング加工品

NC旋盤、カム式旋盤、ヘッダー機、手動旋盤等で顧客仕様図面により製作した別作製品の一部分です。多品種、短納期、少ロット(1個～)に対応致します。



大口径NC旋盤マシニング加工品

大口径NC旋盤及びマシニング等で顧客仕様図面により製作した別作製品の一部分です。多品種、短納期、少ロット(1個～)に対応致します。



鋳造加工品

鋳造機で製作した標準品・別作製品の一部分です。多品種、短納期に対応致します。



プレス加工品(別作蝶番)

プレス機で顧客仕様図面により製作した別作製品の一部分です。多品種、短納期、少ロット(1個～)に対応致します。ボルト止めの蝶番のセルスタット(溶接レス)、ボルト溶接、パーリング加工、穴アケ加工も致します。

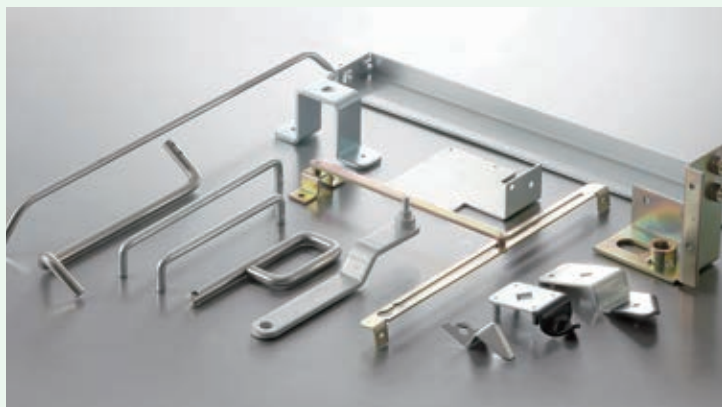

プレス加工品(金具類)

プレス機、ベンダー等で顧客仕様図面より製作した別作製品の一部分です。多品種、短納期、少ロット(1個～)に対応致します。別作ロッド棒、樹脂コーティング処理も承ります。



銅帯加工品

プレス機、ベンダー等で顧客仕様図面により製作した別作製品の一部分です。多品種、短納期、少ロット(1個～)に対応致します。

ホームページのご案内 WEB

ホシモトのホームページでは、商品をカテゴリやキーワードで検索し
詳細を確認することができます。

詳細の確認後、DXFファイルのダウンロードや見積依頼が可能です。
他にも、オーダーメイドでの製品製作においても
ホームページ上でお問い合わせいただけます。

You can check the details by product category or keyword on hoshimoto homepage.

After verifying the details, you can download the DXF file or request a quote.

You can contact us on our website in other make to order products.

■ トップページ Home

商品をキーワードで
検索する場合は、
こちらにキーワードを
入力します。

If you search items by keyword,
enter the keyword here.

「ホシモト」の最新情報を
随時更新し、お伝えします。
"Hoshimoto" inform you of
the latest update information
at any time.

商品をカテゴリ別で
検索できます。

You can search products
by category.



ホシモトで取り扱っている商品が
社会の意外な所で使用されています。
一例を紹介していますので、
ぜひご覧ください。

All hoshimoto products are widely used
in various places of our society.
Some products are introduced,
please have a look.

注目製品を一覧で表示しています。
新製品も、ここでチェックできます。

Featured Products are listed.
You can also check here for new products.

オーダーメイドでの製品製作を
ご希望の方は、こちらから。

Please click here for customers
who want make-to-order products.

ホシモトの最新カタログが閲覧できます。 Latest Hoshimoto catalog is available for viewing.

■ 総合カタログ PRODUCTS CATALOGUE



ホシモトの標準品・準標準品を掲載
しています。
カテゴリーごとにPDFのダウンロード
ができます。

Standard and substandard products of hoshimoto
are listed in catalog.
PDF files are available to download for each
category.

■ パッキンカタログ GASKETS CATALOGUE



ホシモトで取り扱っているパッキンを集
めたカタログです。
総合カタログに掲載しきれなかった商
品も載っています。

It is the catalog which collected gasket handling
in hoshimoto.
Products that could not be listed in the general
catalog are also listed.

■ Newコレクションカタログ NEW COLLECTION CATALOGUE



2013年3月現在の新品を集めたカ
タログです。
総合カタログに掲載しきれなかった商
品も載っています。

It is the catalog which collected new products as
of March, 2013.
Products that could not be listed in the general
catalog are also listed.

ご注文について

あらゆるご注文に対応いたします。お気軽にお問い合わせください。

商品は**1点からでも**
ご注文いただけます。

少量でも
特注対応いたします。
ぜひご相談ください。

まとまった量のご注文は
お見積もりいたします。
お問い合わせください。

ご注文方法

●FAXでのご注文

弊社HPよりFAXご注文書をダウンロードしていただき、必要事項をご記入のうえ、注文書下の番号宛にご送信ください。お客様の書式でも受付いたします。

●お電話でのご注文

商品番号、個数と、お客様情報をお申し付けください。製品に関するご質問も対応いたします。

●インターネットでのご注文

製品情報画面から「見積もりカートへ」へ進み、必要事項を入力してください。各種別作オーダーも承ります。



株式
会社

ホシモト

〒544-0032 大阪市生野区中川西2丁目24番32号

TEL.06-6741-4723 FAX.06-6712-2609

URL <http://www.hoshimoto.co.jp> **E-mail** co@hoshimoto.co.jp